

2024 Product Guide



LONE STAR SHUTTERS
Blinds & Shades

WALDEN
PREMIER



WALDEN

PREMIER

The Walden Premier Collection offers over 35 of the latest bamboo, jute, grass, and natural woven patterns.

All the patterns in the collection can be made into roman shades. Many can be made into folding doors or sliding panels.

The collection brings child safety to your shades with three unique control options: our patented cordless system that can lift even the heaviest shade on a 1½" head rail and our affordable, versatile wand and remote control motorization options.

Enjoy peace of mind with our Limited Lifetime Warranty, covering all aspects of workmanship and quality in your shades.

WALDEN PREMIER MATERIALS REFERENCE

PATTERN CODE	PATTERN NAME	PRICE GROUP	SLIDING PANEL	FOLDING DOOR	COORDINATED WAND COLOR	MAXIMUM SIZE FOR MOTORIZED SHADES (SQUARE FEET) ⁽¹⁾	
						WITHOUT LINER	WITH LINER
E-M01	Aires White	F	Y	N	White	64	64
E-87K	Alder Oak	B	Y	Y	Beige	44	38
E-432	Artisan Weave	E	N	N	Bronze	44	38
E-416	Aspen Cedar	C	Y	Y	Bronze	44	38
E-416-3	Aspen Ebony	C	Y	Y	Black	44	38
E-082	Aspen Walnut	C	Y	Y	Bronze	44	38
E-416-4	Aspen White	C	Y	Y	White	44	38
E-R26	Bamboo Forest	B	Y	Y	Bronze	44	38
E-365	Barcelona Café	B	Y	Y	Bronze	54	44
E-861	Bora Bora	B	Y	Y	Beige	50	42
E-430	Capri Natural	D	Y	N	Beige	64	56
E-389	Catalina	E	Y	N	Beige	64	64
E-E11	Devon Ivory	A	Y	Y	Beige	56	45
E-E06	Devon Maple	A	Y	Y	Beige	56	45
E-E02	Devon White	A	Y	Y	White	56	45
E-68N	Driftwood Natural	B	Y	Y	Beige	44	38
E-055	Java Cocoa	B	Y	Y	Bronze	54	44
E-B01	Mandalay Umber	C	Y	Y	Black	33	30
E-801	Mykonos Dunes	F	Y	N	Beige	64	56
E-390	Natural Jute	E	Y	N	Beige	64	56
E-803	Navarre White Sand	F	Y	N	White	64	56
E-P01	Orleans Macaroon	E	Y	N	White	64	64
E-403-B	Penang Oak	A	Y	Y	Bronze	56	45
E-427	Prairie Golden	E	Y	N	Beige	64	56
E-828	Prairie Snow	F	Y	N	Beige	64	56
E-428	Prairie White	E	Y	N	Beige	64	56
E-M04	Remi Breeze	E	Y	N	Gray	64	56
E-001	Sakura Oregano	C	Y	N	Bronze	54	44
E-352	Savanna Husk	C	Y	N	Bronze	64	56
E-U01	Saybrook Stone	E	Y	N	Gray	56	45
E-U03	Seaside White	F	Y	N	Beige	56	45
E-370	Sierra Sand	D	N	N	Bronze	50	42
E-438	Sunshade Brown	A	Y	Y	Bronze	54	48
E-10H	Sunshade White	C	Y	Y	White	44	38
E-394	Tamarind Sunset	B	Y	Y	Bronze	44	38
E-805	Telluride Frost	D	Y	Y	White	44	38
E-806	Telluride Thunder	D	Y	Y	Beige	44	38

EDGE BINDINGS

COLOR	COLOR NUMBER	WIDTH
NARROW EDGE BINDING		
Beige	N3	1"
Black	N10	1"
Chocolate	N4	1"
Copper	N5	1"
Cream	N8	1"
Desert Sand	N6	1"
Light Beige	N2	1"
Natural	N15	1"
Sienna	N11	1"
White	N1	1"
WIDE EDGE BINDING		
Beige	W3	3"
Black	W10	3"
Chocolate	W4	3"
Copper	W5	3"
Cream	W8	3"
Desert Sand	W6	3"
Light Beige	W2	3"
Natural	W15	3"
Sienna	W11	3"
White	W1	3"

Edge Binding on the face of the shade will be 1/2 the width above.

LINERS

COLOR NUMBER	COLOR
PRIVACY LINERS	
NK-L	Privacy Beige
NC-L	Privacy Chocolate
W4-L	Privacy White
BLACK-OUT LINERS	
K3-D	Black-Out Beige
C2-D	Black-Out Chocolate
W4-D	Black-Out White

Privacy Liners are the same color on both sides.

Black-Out Liners are off-white to the street.

All fabrics have a maximum width of 96".

⁽¹⁾ Motorized square foot size restrictions do not apply to Power Lift motors.

SHADE STYLES

FABRIC SELECTION

The fabrics in this collection are made from natural materials, which are subject to variation in color, texture, and weave. Like any wood or bamboo product, fabrics may show natural color changes over time.

Natural fabrics are not ideal for rooms with excessive humidity like bathrooms. Shades installed in these environments may bow or twist over time.

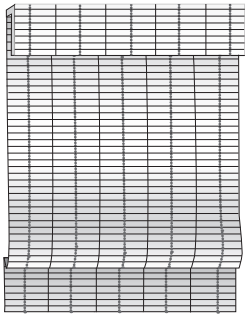

STANDARD ROMAN SHADE

Shade material is attached to the back of the head rail. Shade includes a 6" valance to conceal the components. When raised, the material rises from the bottom in flat folds.

Shades operated by cord loop will have controls in front of the shade.

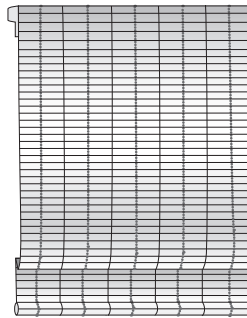

WATERFALL SHADE

Shade material is attached to the front of the head rail, without a valance. When raised, the material rises from the bottom in flat folds. Optional back valance is available upon request.

Shades operated by cord loop will have controls behind the shade.

VALANCE RETURNS

Outside mount shades are recommended to be ordered with valance returns. Returns for both outside and inside mount shades are available free of charge if requested at the time the order is placed.

Standard valance returns are made using the shade material. Valance returns can also be made using edge binding material upon request; this is a surcharge option.

Standard valance return height will be 1½" less than the valance height. This length will keep the rolled bottom of the valance from interfering with the return.

Optional short valance returns are also available. Short returns cover the end of the head rail and hide the components, keeping the stack of the raised shade away from the returns.

Custom valance return lengths are available to be ordered upon request.

All valance returns will be made with an L-shaped connector to attach to the back of the valance. This holds the returns in place and creates a clean, finished corner.

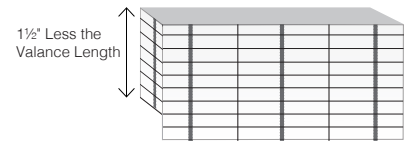

Standard Valance Return

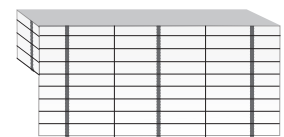

Short Valance Return

BOTTOM BAR

Clutch and motorized shades will be made with a round bottom bar. Cordless shades are made with a rectangular bottom bar.

SHADE OPTIONS

LINERS

A liner can be ordered attached to the back of the shade or as a separate operable, movable liner (see Twin Shade below).

ATTACHED LINERS

Attached liners are available in privacy or black-out. They are secured to the back of the shade by stitches at each side of the liner. If a shade is lined, the valance will automatically be lined with the same material.

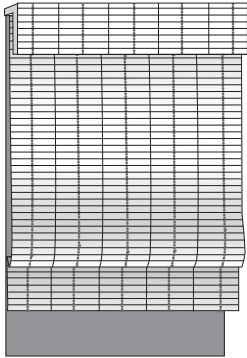

TWIN SHADE

Features two separate, independently operated shades on one head rail. The front shade can be either a standard or waterfall woven wood shade.

A separate liner shade is attached to the back of the head rail and both shades operate independently.

Outside mount twin shades will be made with a valance that is $\frac{3}{4}$ " wider than the ordered shade width. This will allow the returns to fit behind the valance.

See Specifications for head rail sizes.

Not available as 3-on-1 head rail.

MULTIPLE SHADES ON ONE HEAD RAIL

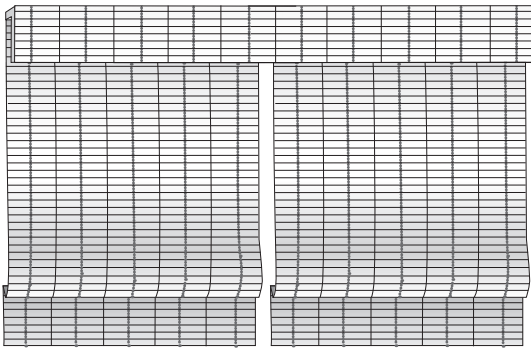

shown with two shades

Shades are available with 2-on-1 or 3-on-1 head rail. The maximum total width is 103" and the gap between shades will be no more than $\frac{1}{2}$ ". The maximum width for a common valance is 96"; wider valances will be made in sections to match the individual shade widths.

Multiple shades on one head rail are available to be ordered with all control types. Pay careful attention to make sure there are suitable locations for cord tensioners when specifying multiple shades on one head rail, particularly for the middle shade in 3-on-1 head rail units.

SHADE CONTROL OPTIONS

CORDLESS SHADES

Cordless shades operate with no lift cords on the front of the shade. The shade is lowered by pulling on the hem bar. A spring control system, located under the wooden head rail, holds the shade in place at any desired position.

Clear grips are added to the hem bar of cordless shades; one per shade up to 72" wide and two for wider shades.

Cordless shades are available up to 96" wide and 96" long and will be mounted on standard depth head rails (see Specifications for details).

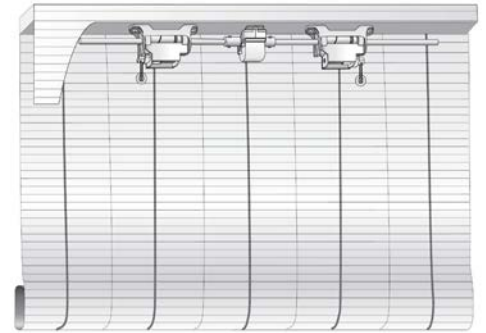

Cordless Shade

CLUTCH CONTROLS

Clutches provide an assisted lift for large or heavy shades and come standard with color-coordinated cord loops available in one foot increments from 2' to 6'. The factory will choose the length closest to $\frac{2}{3}$ the shade height, unless otherwise requested. Nickel-plated bead chain loops are available as a surcharge option and can be made to custom lengths. Clutches are available with all shade styles.

Compliant cord tensioners are provided with clutch control shades. Cord tensioners secure the cord loop to the wall or window. They must be installed for the shade to be compliant with safety regulations and to operate properly.

Standard shades ordered with a clutch come "clutch adjacent" to keep the stack of the raised shade from interfering with the loop. This means the shade fabric will be narrower than the ordered width on the control side, allowing the cord to hang to the side of the shade (see diagram). This may cause a light gap on black-out shades.

Waterfall shades ordered with clutch controls will have control loops behind the shade and are not available to be ordered as clutch adjacent.

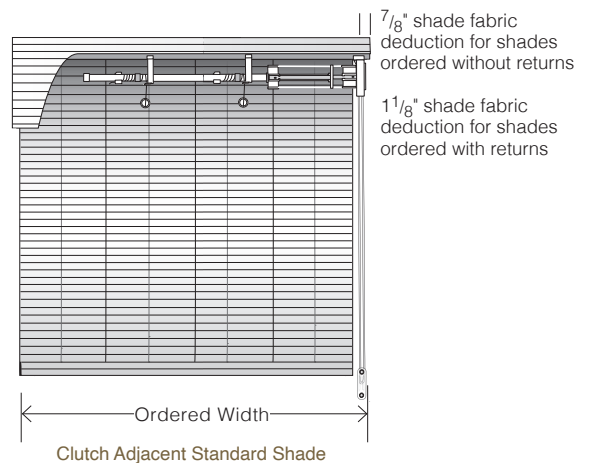
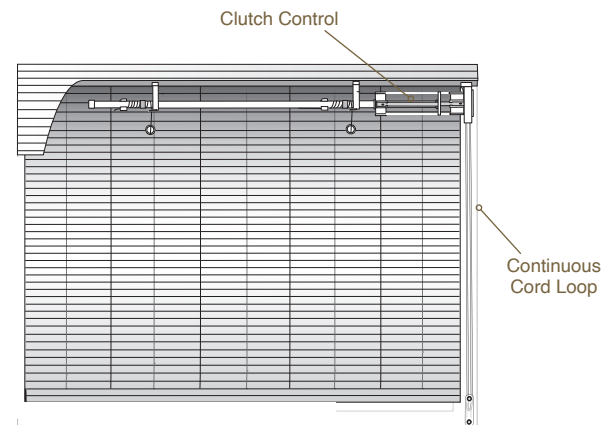

SHADE CONTROL OPTIONS

REMOTE CONTROL SHADES

Remote motors have rechargeable and hardwired options available which can be controlled with remotes, wall switches, or motor hubs.

See Specifications for minimum widths by motor type.



Remote
(multi-channel)



Wall Switch
(multi-channel)

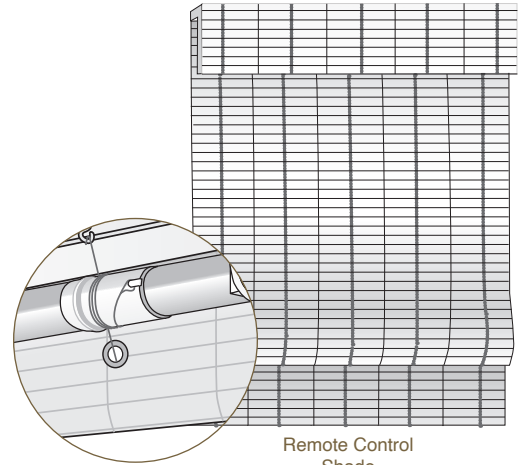

Motor tube and spindle

Remote Control
Shade

REMOTE MOTOR OPTIONS

	RECHARGEABLE LITHIUM ION	12 V DC HARDWIRED	12 V DC EXTERNAL POWER	100-240 AC HARDWIRED ^[1]
MOTOR TYPE	Standard Lift ^[2] Power Lift	Standard Lift ^[2]	Standard Lift ^[2]	Standard Lift ^[2]
POWER SUPPLY	Internal	Hardwired	AA Battery Tube External LI Battery Pack	Hardwired <i>AC wall plug not available through this collection</i>
CHARGER	6'/16½' Micro-USB	-	6'/16½' Micro-USB <i>Used to recharge LI Battery Pack</i>	-
REMOTE	Single/15 Channel Remote Single/15-Channel Wall Switch	Single/15 Channel Remote Single/15-Channel Wall Switch	Single/15 Channel Remote Single/15-Channel Wall Switch	Single/15 Channel Remote Single/15-Channel Wall Switch
AUTOMATION	Pro Hub	Pro Hub	Pro Hub	Pro Hub

^[1]Requires installation by an electrician.

^[2]Standard Lift motors have maximum sizes as noted by in the Materials Reference table. For shades above these sizes, please use the Power Lift motor.

PRO HUB

Connects through 2.4 GHz wifi or directly to router with ethernet cable.

Works with Connector+ App, Amazon Alexa, Control4, Google Home, IFTTT, RTI, Samsung Smart Things, and Siri Short Cuts.



Pro Hub

SHADE CONTROL OPTIONS

WAND CONTROL SHADES

Wand control motorized shades are powered by the same internal lithium-ion battery as remote control shades. The motor is controlled using a wand which hangs down to the side of the shade.

Waterfall shades cannot be ordered with wand controls.

Wands are available in 4 lengths: 24", 36", 48", and 60". Available colors include: white, beige, gray, bronze, and black.

Wand control shade motor batteries are recharged via a mini USB power adaptor which plugs into the end of the wand.

Check the Materials Reference table for the maximum size of shade which can be operated by this battery motor.

All wand control shades will be made with shade fabric $\frac{5}{8}$ " narrower for inside mount and $\frac{7}{8}$ " narrower for outside mount than the ordered width on the control side, allowing the wand to hang to the side of the shade. This may cause a light gap on black-out shades.

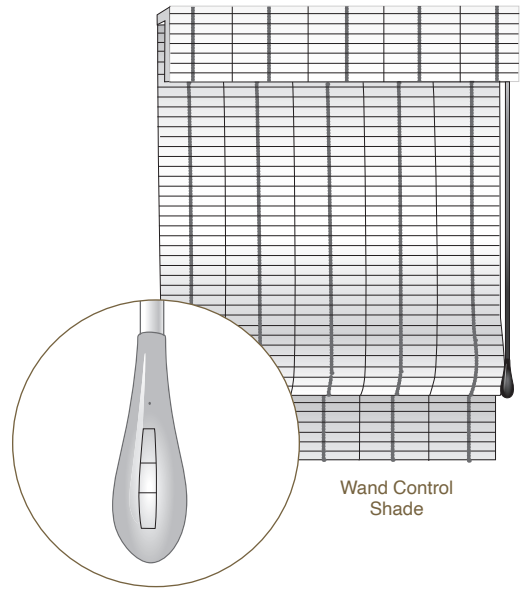

White, beige, gray, bronze, or black wands

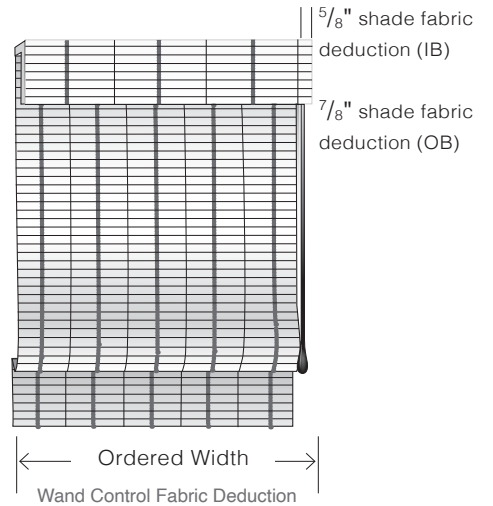

SHADE ADDITIONAL OPTIONS

ADDITIONAL OPTIONS

LINED VALANCE

Lined valances are recommended to conceal the head rail components where an open-weave pattern is selected.

BACK VALANCE/INTERIOR VALANCE (WATERFALL SHADES)

Back valances for waterfall shades are available upon request and can be ordered in either the shade fabric or the liner fabric for lined shades. Back valances conceal the shade components from the back of the shade.

Interior valances come standard with waterfall shades that are unlined or that are ordered with a light-filtering liner. Interior valances block the outline of the shade components from showing on the front of the shade. Valances are 4" long and are made with black-out White (W4-D) liner material. Because the valance is made with black-out fabric, the part of the shade in front of the interior valance will look darker than the rest of the shade when light is coming through.



Waterfall Shade
with interior and back valances

EDGE BINDINGS

Available in two widths: 1" (1/2" on the face of the shade) and 3" (1 1/2" on the face of the shade).

Edge binding is applied to the sides of both the shade and valance. It is not applied to the bottom of either.

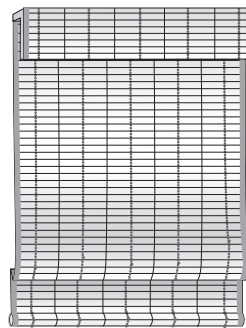

Standard Shade
shown with narrow edge binding

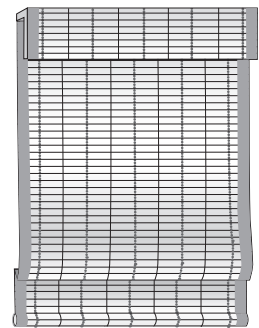

Standard Shade
shown with wide edge binding

CUT OUTS

Cut outs can be taken from either side of the shade. Exact dimensions and the locations of the cut outs are required.

Cut outs are not available with edge binding.

There may be limitations to what can be cut out, based upon the size and specifications of the shade. The factory will review all orders for cut outs and provide confirmation of each order within 24 hours.

HOLD DOWN BRACKETS AND SPACER BLOCKS

Hold down brackets are supplied upon request for all control types. Clutch and motorized shades ordered with hold down brackets will be made with a round bottom bar. Cordless shades with hold down brackets will be made with a rectangular bottom bar.

Spacer blocks measuring 3/8" are available upon request. Maximum of 2 spacer blocks per bracket recommended.

VALANCE ONLY

Valance Only is available for all fabrics. Valances can be specified in length up to 18" long and have a maximum width of 96". Valance returns will be made to the ordered length of the valance or can be requested in custom lengths.

Valances can be ordered attached to a head rail or loose. Available head rail depths for attached valances are:

1", 1 1/2", 2 3/4", 3 1/2", or 5".

Valances can be made with liners and edge binding for a surcharge. Please specify if valances should be lined or unlined or made with or without edge binding when placing your order.

SHADE SPECIFICATIONS

	MINIMUM WIDTH	MAXIMUM WIDTH	MINIMUM HEIGHT	HEIGHT	IB DEDUCTION (WIDTH)	FLUSH IB DEPTH (top mount w/brkt)	MINIMUM IB DEPTH (top mount w/brkt)
CORDLESS	18 ^{**}	96"	18"	96"	3/8"	2 1/2 [*]	3/4"
CORDLESS TWIN	18"	96"	18"	96"	3/8"	4 1/2 [*]	3/4"
CLUTCH and LOOP	18"	96"	18"	108"	3/8"	2 1/2 [*]	3/4"
WAND CONTROL	23"	96"	18"	108"	3/8"	3 3/4 [*]	3/4"
Remote Control Motors							
• STANDARD LITHIUM ION	23"	96"	18"	108"	3/8"	3 3/4 [*]	3/4"
• STANDARD DC MOTOR	15"	96"	18"	108"	3/8"	3 3/4 [*]	3/4"
• STANDARD AC MOTOR	20"	96"	18"	108"	3/8"	3 3/4 [*]	3/4"
• POWER LIFT	29 1/2"	96"	18"	108"	3/8"	3 3/4 [*]	3/4"
MULTIPLE SHADES ON ONE HR	-	103" total	-	-	-	-	-
COMMON VALANCE	-	96"	-	-	-	-	-
VALANCE ONLY	-	96"	-	18"	-	-	-

* Flush IB depth is head rail depth plus 1" when using standard bracket. Exact measurement will vary slightly based upon fabric thickness.

** Cordless shades can be made as narrow as 15". However, when made this narrow, the shade may be prone to twisting.

BRACKET DIMENSIONS

Height: 1 1/2"

Depth: 1 3/4"

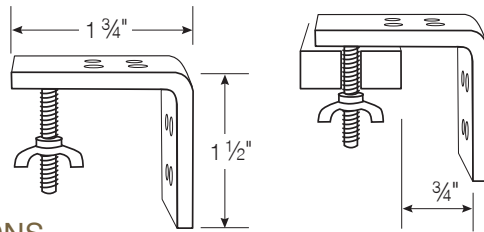

RING SPACING

First fold starts at 3 1/2" above the bottom bar, then rings are spaced 7" apart on back of the shade.

HEAD RAIL DIMENSIONS

Middle support brackets will be supplied for all shades over 41" wide.

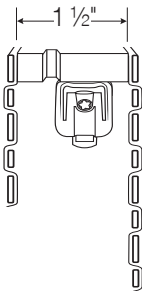

CORDLESS HEAD RAIL

- Standard Shades
- Waterfall Shades

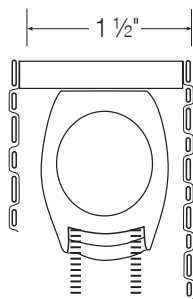

CLUTCH SHADE

with Continuous Cord Loop (shown)

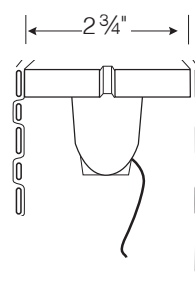

MOTORIZED HEAD RAIL

REMOTE OR WAND CONTROL

- Standard Shades
- Waterfall Shades

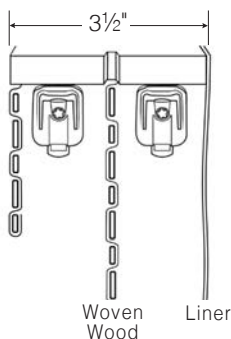

TWIN SHADE w/CORDLESS

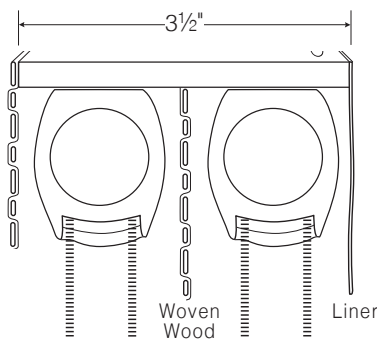

TWIN SHADE w/2 CLUTCHES

Controls Same Side (shown) or Opposite Sides

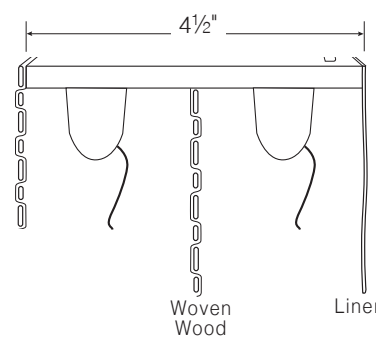

TWIN SHADE w/2 MOTORS

Controls Same Side (shown) or Opposite Sides

FOLDING DOORS

Folding doors are ideal for large windows or doors and hang vertically from hangers, which slide smoothly inside an aluminum track. On each side of the door are wood bars with handles, if desired. The wood bars come in five colors, and are selected to coordinate with the chosen pattern. All folding doors are provided with a brown track; white is available upon request.

Check the Materials Reference table for patterns which are available to be made as folding doors.

Folding doors come in one of two configurations: one-way opening or center opening.

ONE-WAY OPENING

When open, the material stacks back either to the right or the left. Specify on the order form which side of the door the drapery will stack to.

NOTE: *If you want the material to stack back completely clear of the window, for an unobstructed view when the door is open, allow for the width of the stack in the overall width of the door. See "Specifications" for more details.*

CENTER OPENING (Split Draw)

The door is made from two panels, which are equal width and meet in the middle. They open to opposite sides of the window.

Each panel has a wood bar on both sides and the two middle bars have small, countersunk magnets which hold the two bars together tightly when the panels are in the closed position.

DRAPERY STYLE

Folding doors can be ordered "drapery style," which means no edge bars. Instead, they will have edge binding on all four sides of each panel for a softer look. Wide edge binding will be used on the top panel, bottom, and sides.

Drapery style folding doors can also be ordered as one-way or center opening.

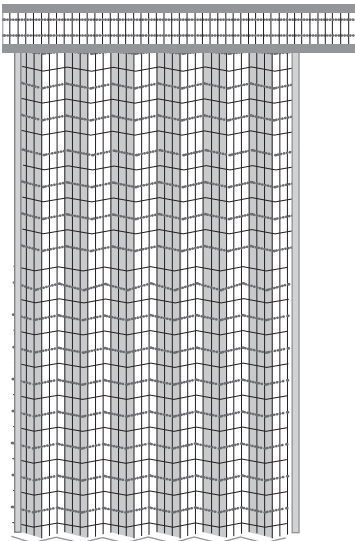

One-Way Left Stack
shown with valance

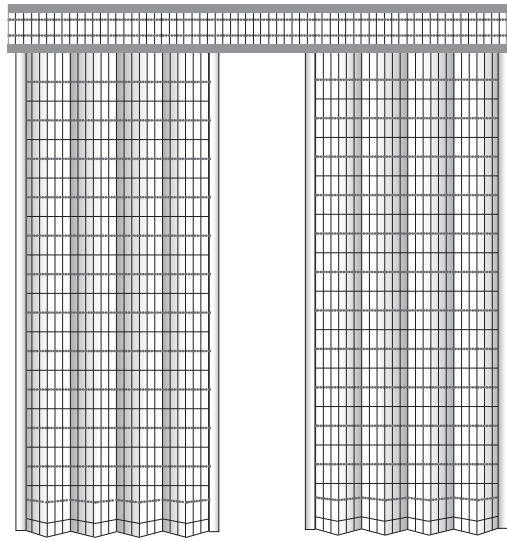

Center Opening – Split Draw
shown with valance

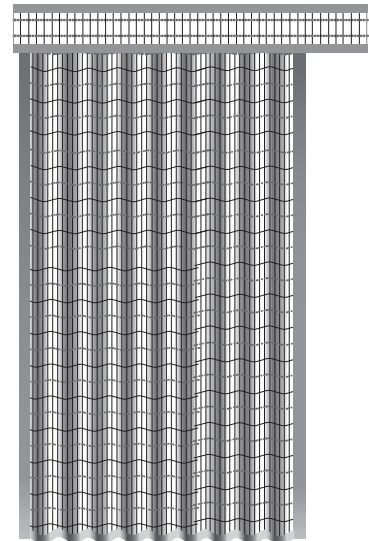

Drapery Style Left Stack
shown with valance

FOLDING DOOR OPTIONS

FULLNESS

The standard folding door comes with 5% fullness, which means that it lies nearly flat when fully extended. Folding doors can be ordered with 20% fullness, which gives fuller folds; this is a surcharge option.

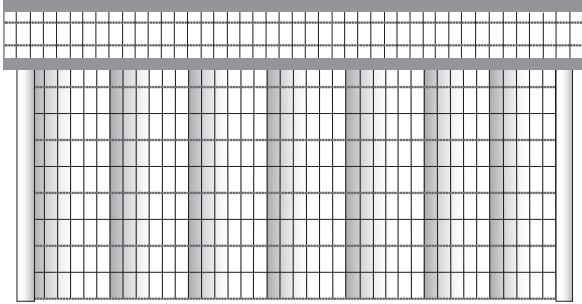

5% Fullness (fully extended)
shown with valance

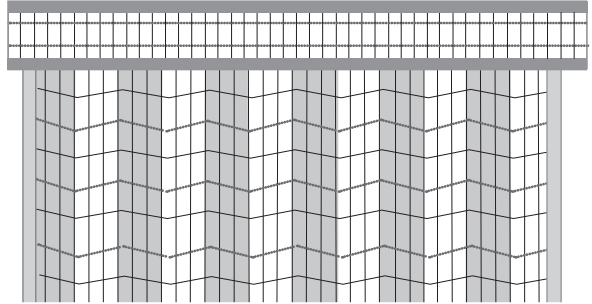

20% Fullness (fully extended)
shown with valance

LINERS

Liners are available in light-filtering or black-out. They are attached to the top of the folding door and are secured down both sides beneath the wood bars.

VALANCE

Standard folding doors come with track and panels. Adding a valance provides a decorative touch. It also conceals the track and hangers and blocks any light gap between the track and the top of the door fabric.

The valance is 8" long and is mounted to a wooden board, 5 1/2" deep and 3/4" thick. The valance is attached to the front edge of the board by velcro.

The valance is oriented in the same direction as the door (vertically) and is edge-bound on the top and bottom. Narrow edge binding is standard on folding door valances.

For inside mount shades, the valance will cover the front of the valance board only. For outside mount shades, the valance will be made to wrap around both ends of the valance board.

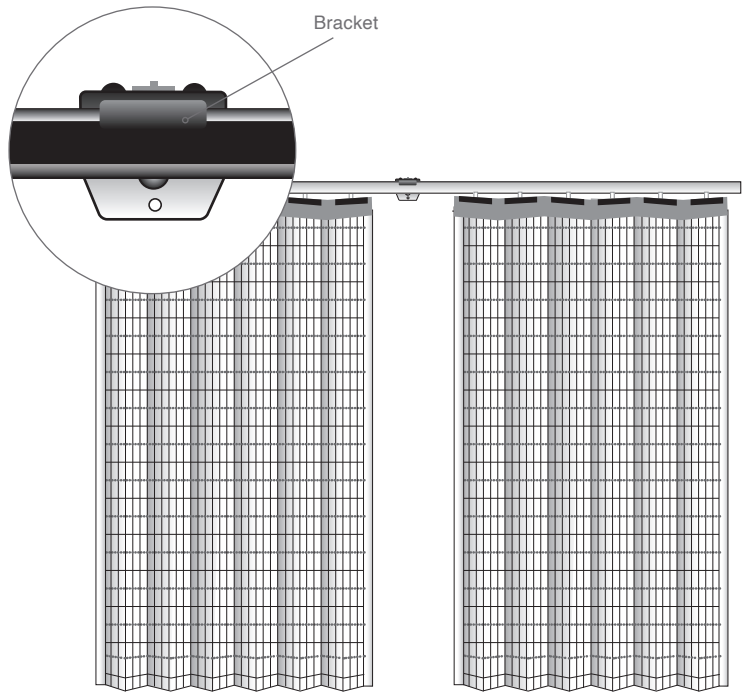

Center Opening – Split Draw
shown without valance

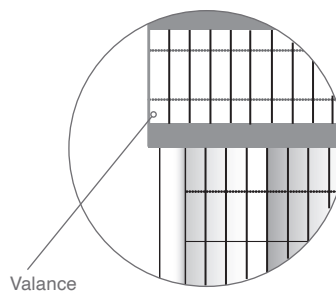

FOLDING DOOR SPECIFICATIONS

SIZE LIMITATIONS

Minimum Width: 24"
Maximum Width: 192"

Minimum Height: 24"
Maximum Height: 96"

Tracks and valance boards wider than 90" are spliced to avoid oversize freight charges.

IMPORTANT INFORMATION FOR ORDERING AND INSTALLING FOLDING DOORS

DOORS WITHOUT A VALANCE

For doors without a valance, the height of the folding door is measured from the top of the track to the bottom of the fabric.

There is a gap of approximately $\frac{3}{4}$ " between the top of the track and the material. The factory will deduct this amount from the ordered length when they make the fabric panel.

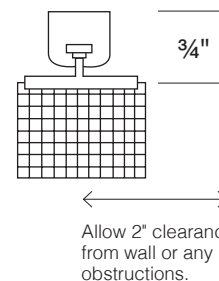

DOORS WITH A VALANCE

For doors with a valance, the height of the folding door is measured from the top of the valance board to the bottom of the fabric.

The valance board is $\frac{3}{4}$ " thick and there is $\frac{3}{4}$ " between the top of the track and the top of the material. The factory will deduct $1\frac{1}{2}$ " from the ordered length when they make the fabric panel.

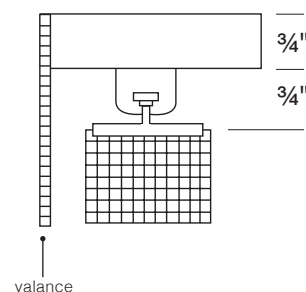

INSIDE MOUNT MEASUREMENTS

Minimum Inside Mount Depth: 2"

Check for any obstructions, such as trim or handles that may interfere with the opening and closing of the door.

Inside Mount Deductions:

Width: $\frac{1}{4}$ "
Height: $\frac{3}{4}$ "

No deductions are made to the width or height of outside mount doors.

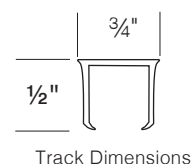
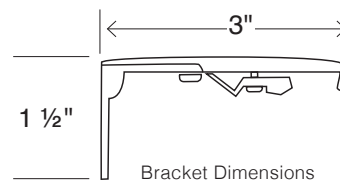

STACKING CHART (5% FULLNESS)

WIDTH	STACK
36"	8 $\frac{1}{2}$ "
42"	9"
48"	9 $\frac{1}{2}$ "
60"	11"
72"	12"
84"	13"
96"	14"

Center opening (or split draw) folding doors will open into two equal stacks on each side. For example a 96" center opening will have two stacks each the size of a 48" one-way opening door: 9 $\frac{1}{2}$ ".

20% fullness folding doors will stack approximately 1" wider for small doors and 1 $\frac{1}{2}$ " wider for larger doors than same size at 5% fullness.

All stacking dimensions are approximate and will vary by pattern.

SLIDING PANELS

CONSTRUCTION AND OPERATION

- Sliding panels provide a clean, contemporary look for large windows and doors.
- Overlapping panels are suspended from hangers, which glide smoothly on an aluminum track and pass in front or behind each other, allowing panels to stack away from the window.
- Panels are attached to the track and are supplied with narrow edge binding to protect them from wear and tear and are custom sized, based on the ordered width and the number of panels.
- Sliding panels are operated with 48" wood wands; a center-opening sliding panel will have two wands.
- Check the Materials Reference table for patterns which are available to be made as Sliding Panels.



Wand Colors

NOTE: Because bamboo and natural materials can stretch or shrink, we recommend that panels are ordered with at least $\frac{3}{4}$ " clearance from the ground. When shipped from the factory, panels may be slightly different lengths (up to $\frac{1}{2}$ " from the ordered length). A shorter panel can be corrected by gently pulling on the bottom of the panel until it is the same length as longer panels.

ONE-WAY OPENING

- When open, all of panels stack back to either the right or the left. *Specify on the order to which side of the window the panels will stack.*
- The standard configuration is for the back panel to be stationary and all the other panels stack in front.
- Reverse stacking is available, with the front panel stationary. Free-floating panels are also available.
- **NOTE:** If you want the panels to stack completely away from the window for an unobstructed view, allow for the panel width in the overall width of the shade. See "Specifications" for more details.



One-Way Left Stacked

CENTER OPENING (SPLIT DRAW)

- Must be made with an even number of panels. Panels stack to both sides.
- When made with four panels, the front left and back right panels are stationary.
- If made with six or eight panels, the back panels on both sides will be stationary and all other panels will stack in front on both sides. See Sliding Panel Configurations on page 17.
- Reverse stacking and free-floating panels are also available.

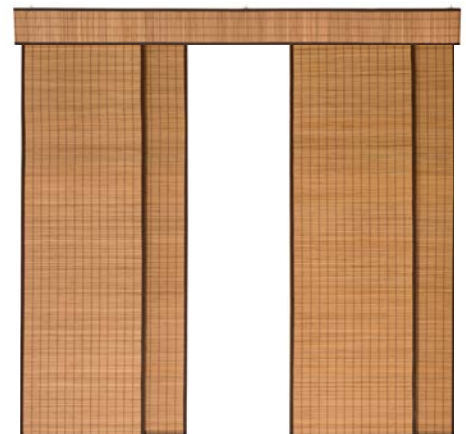

Center Opening

SLIDING PANELS

LINERS

- Available in light-filtering or black-out.
- Sewn under the edge binding on all four panel sides.

EDGE BINDING

- Panels will come with narrow (1") edge binding as standard, which means that ½" is visible on the face of the panels.
- Wide (3") edge binding is also available in the same colors as a surcharge option.

VALANCE

- Valances are 8" long and attached to the front and sides of the track by velcro. If a valance is part of the original sliding panel order, the velcro for the valance will be riveted to the front of the track to ensure a lasting bond.
- Valances are cut up the roll, so they wrap around the ends of the track. This means the valance material is railroaded and will be oriented differently to the panels. For inside mount sliding panels, the valance will cover the front of the track only. For outside mount sliding panels the valance will be made to wrap around both ends of the track.
- When ordered separately, both velcro halves are provided, but the bond between the velcro and the track will not be as durable.

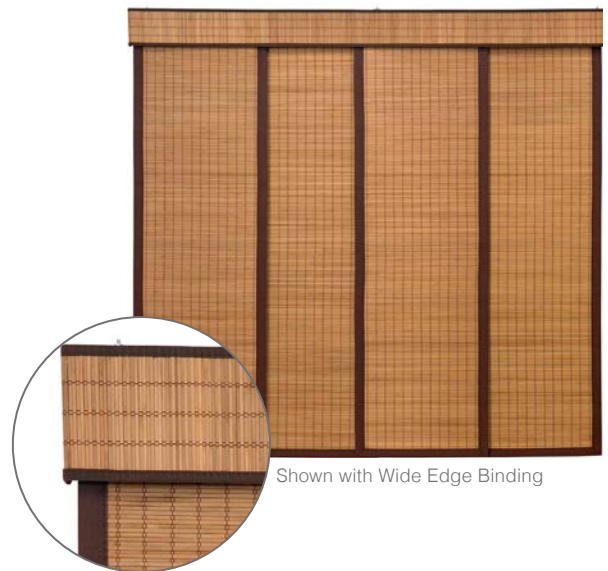

SLIDING PANEL SPECIFICATIONS

SIZE LIMITATIONS

Minimum Width: 48" Minimum Height: 24"
 Maximum Width: 144" Maximum Height: 120"

Tracks wider than 90" are spliced to avoid oversize freight charges.

STANDARD PANEL CONFIGURATIONS

WIDTH	TYPE OF OPENING	# OF PANELS	TRACK TYPE
48" – 84"	One-Way	3 Panels	3 Channel
	Center Opening	4 Panels	2 Channel
84 1/4" – 120"	One-Way	4 Panels	4 Channel
	Center Opening	4 Panels	2 Channel
120 1/4" – 144"	One-Way	5 Panels	5 Channel
	Center Opening	6 Panels	4 Channel

TYPICAL PANEL SIZES (OUTSIDE MOUNT SHADE)

WIDTH	ONE-WAY DRAW		CENTER OPENING	
	60"	3 panels	21 5/8"	4 panels
72"	3 panels	25 5/8"	4 panels	19 7/8"
84"	3 panels	29 5/8"	4 panels	22 7/8"
96"	4 panels	25 7/8"	4 panels	25 7/8"
108"	4 panels	28 7/8"	4 panels	28 7/8"
120"	4 panels	31 7/8"	4 panels	31 7/8"
132"	5 panels	28 3/8"	6 panels	24 1/8"
144"	5 panels	30 3/4"	6 panels	26 1/4"

PANEL SIZE CALCULATIONS

To calculate the approximate panel width, use the ordered width and the number of panels.

Deduct one from the number of panels and multiply this number by 2.5. Then add this number to the ordered width and divide the resulting number by the number of panels.

For example: For a sliding panel order with an 80" width and 5 panels, each panel will be approximately 18" wide.

$$5 \text{ (panels)} - 1 = 4$$

$$4 \times 2.5 = 10"$$

$$80" \text{ (ordered width)} + 10" = 90"$$

$$90" / 5 \text{ (panels)} = 18" \text{ panel width}$$

TRACK DIMENSIONS

TRACK DEPTHS	
3 Channel	2"
4 Channel	2 3/4"
5 Channel	3 3/8"

The distance from the top of the track to the top of the panels is 1". The factory will take account of this distance when calculating the panel length.

MOUNTING DEPTHS

	3 TRACK	4 TRACK	5 TRACK
Minimum IB	2"	2 3/4"	3 3/8"
Flush IB	2 1/2"	3 1/4"	3 7/8"

Wall or Face Mount: 1 3/4" flat mounting surface required.
(Using L Bracket)

INSIDE MOUNT DEDUCTIONS

IB Deduction (Width): 1/4"

IB Deduction (Height): 1/2"

DISTANCE FROM THE WALL TO THE BACK OF THE TRACK (CLEARANCE)

	3-CHANNEL TRACK	4-CHANNEL TRACK	5-CHANNEL TRACK
Standard Bracket (2 7/8")	1 3/8"	1 1/4"	3/4"
Large Bracket (4 1/4")	2 1/2"	2 3/8"	1 7/8"

Adding an extension bracket will provide an extra 2 7/8" of clearance from the wall.

Add the track depth to the clearance to calculate the total projection into the room.

SLIDING PANEL BRACKET

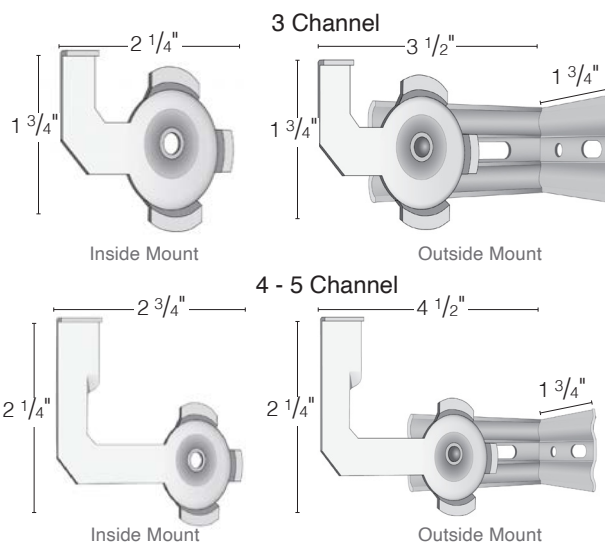

SLIDING PANEL CONFIGURATIONS

GENERAL OPERATION

Open

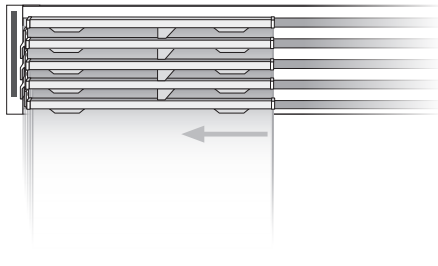

Closed

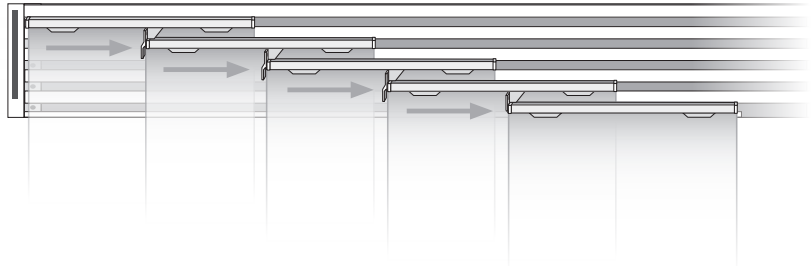

ONE WAY CONFIGURATIONS

3 Channel Track / 3 Panels / One Way Left

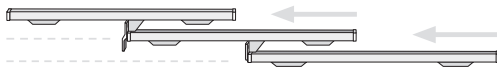

3 Channel Track / 3 Panels / One Way Right

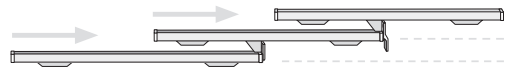

4 Channel Track / 4 Panels / One Way Left

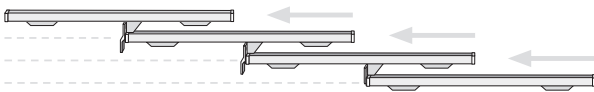

4 Channel Track / 4 Panels / One Way Right

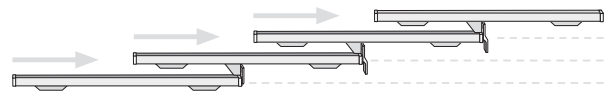

5 Channel Track / 5 Panels / One Way Left

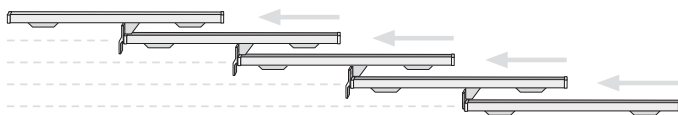

5 Channel Track / 5 Panels / One Way Right

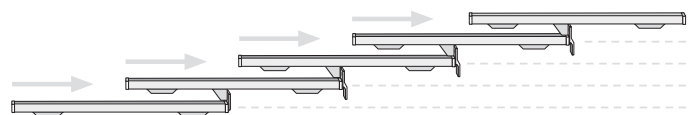

CENTER SPLIT CONFIGURATIONS

2 Channel Track / 4 Panels / Center Split
stationary front left and back right

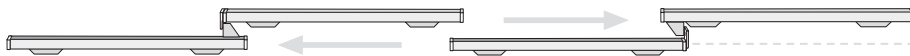

4 Channel Track / 6 Panels / Center Split

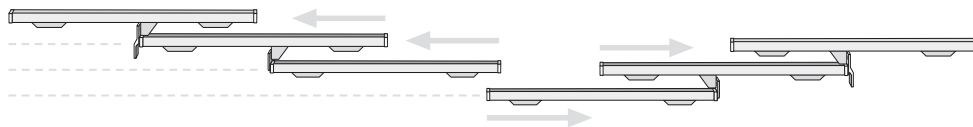

5 Channel Track / 8 Panels / Center Split

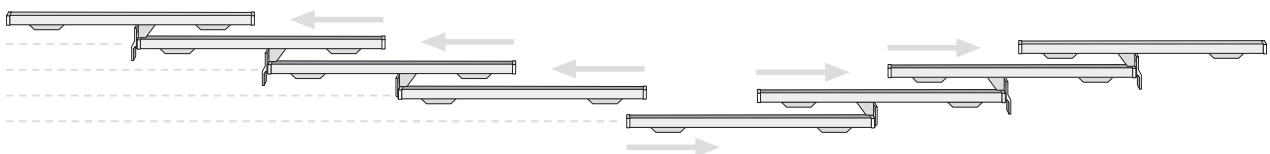

SHADE PRICING GROUPS A - C

Pricing includes Cordless and Clutch shades.

WIDTH

PRICE GROUP A Devon Penang Oak Sunshade Brown	LENGTH	24"	30"	36"	42"	48"	60"	72"	84"	96"
		36"	\$278	\$284	\$321	\$345	\$371	\$465	\$506	\$587
48"	\$302	\$331	\$358	\$391	\$420	\$530	\$576	\$672	\$724	
54"	\$315	\$358	\$378	\$410	\$449	\$563	\$620	\$712	\$774	
60"	\$327	\$368	\$400	\$431	\$463	\$590	\$666	\$752	\$824	
66"	\$338	\$378	\$420	\$453	\$490	\$653	\$705	\$813	\$893	
72"	\$350	\$394	\$440	\$476	\$513	\$676	\$735	\$874	\$960	
78"	\$366	\$413	\$460	\$505	\$549	\$709	\$784	\$916	\$1,010	
84"	\$380	\$431	\$482	\$530	\$586	\$742	\$818	\$960	\$1,071	
96"	\$406	\$464	\$523	\$578	\$632	\$825	\$924	\$1,076	\$1,203	
108"	\$443	\$509	\$575	\$637	\$697	\$910	\$1,020	\$1,190	\$1,332	
VALANCE ONLY	18"	\$138	\$142	\$172	\$192	\$213	\$260	\$292	\$340	\$373

PRICE GROUP B Alder Oak Bamboo Forest Barcelona Café Bora Bora Driftwood Natural Java Cocoa Tamarind Sunset	LENGTH	24"	30"	36"	42"	48"	60"	72"	84"	96"
		36"	\$314	\$335	\$374	\$397	\$420	\$506	\$556	\$651
48"	\$357	\$394	\$431	\$463	\$495	\$582	\$638	\$752	\$851	
54"	\$367	\$410	\$452	\$487	\$522	\$617	\$679	\$803	\$901	
60"	\$380	\$426	\$472	\$510	\$548	\$653	\$721	\$851	\$952	
66"	\$394	\$444	\$493	\$535	\$576	\$688	\$764	\$897	\$1,000	
72"	\$409	\$462	\$515	\$559	\$604	\$721	\$807	\$943	\$1,048	
78"	\$421	\$479	\$536	\$585	\$632	\$757	\$848	\$987	\$1,099	
84"	\$434	\$496	\$556	\$608	\$659	\$792	\$890	\$1,032	\$1,150	
96"	\$464	\$551	\$598	\$657	\$714	\$893	\$1,010	\$1,165	\$1,293	
108"	\$509	\$585	\$658	\$724	\$789	\$986	\$1,118	\$1,290	\$1,432	
VALANCE ONLY	18"	\$166	\$183	\$215	\$233	\$251	\$292	\$333	\$390	\$443

PRICE GROUP C Aspen Mandalay Umber Sakura Oregano Savanna Husk Sunshade White	LENGTH	24"	30"	36"	42"	48"	60"	72"	84"	96"
		36"	\$347	\$378	\$413	\$433	\$472	\$593	\$669	\$808
48"	\$373	\$416	\$459	\$486	\$513	\$665	\$752	\$904	\$1,039	
54"	\$390	\$437	\$485	\$516	\$546	\$695	\$811	\$970	\$1,088	
60"	\$409	\$459	\$507	\$543	\$586	\$744	\$848	\$1,010	\$1,158	
66"	\$427	\$479	\$530	\$568	\$621	\$792	\$909	\$1,079	\$1,228	
72"	\$443	\$499	\$553	\$594	\$649	\$850	\$975	\$1,157	\$1,314	
78"	\$462	\$520	\$579	\$631	\$697	\$891	\$1,022	\$1,214	\$1,383	
84"	\$477	\$540	\$604	\$668	\$731	\$932	\$1,071	\$1,270	\$1,451	
96"	\$510	\$582	\$651	\$721	\$803	\$1,039	\$1,210	\$1,419	\$1,610	
108"	\$562	\$642	\$718	\$799	\$890	\$1,152	\$1,343	\$1,575	\$1,790	
VALANCE ONLY	18"	\$193	\$218	\$246	\$261	\$292	\$363	\$423	\$516	\$595

SHADE PRICING GROUPS D - F

Pricing includes Cordless and Clutch shades.

WIDTH

PRICE GROUP D		24"	30"	36"	42"	48"	60"	72"	84"	96"	
Capri Natural Telluride Sierra Sand	36"	\$386	\$400	\$437	\$460	\$482	\$617	\$698	\$840	\$962	
	48"	\$397	\$436	\$489	\$519	\$549	\$702	\$800	\$957	\$1,092	
	54"	\$416	\$472	\$528	\$555	\$582	\$742	\$850	\$1,015	\$1,160	
	60"	\$433	\$500	\$552	\$589	\$614	\$782	\$900	\$1,074	\$1,226	
	66"	\$452	\$516	\$579	\$612	\$647	\$874	\$985	\$1,158	\$1,322	
	72"	\$472	\$530	\$591	\$637	\$681	\$911	\$1,048	\$1,243	\$1,415	
	78"	\$486	\$552	\$616	\$712	\$731	\$954	\$1,099	\$1,304	\$1,486	
	84"	\$507	\$575	\$642	\$746	\$781	\$999	\$1,151	\$1,362	\$1,560	
	96"	\$546	\$622	\$697	\$754	\$849	\$1,134	\$1,309	\$1,551	\$1,769	
	108"	\$601	\$687	\$771	\$836	\$941	\$1,257	\$1,455	\$1,725	\$1,970	
VALANCE ONLY		18"	\$224	\$235	\$265	\$283	\$301	\$383	\$446	\$541	\$639

PRICE GROUP E		24"	30"	36"	42"	48"	60"	72"	84"	96"	
Artisan Weave Catalina Natural Jute Orleans Macaroon Prairie Golden Prairie White Remi Breeze Saybrook Stone	36"	\$414	\$429	\$470	\$496	\$519	\$665	\$754	\$907	\$1,042	
	48"	\$426	\$469	\$527	\$560	\$593	\$758	\$866	\$1,037	\$1,185	
	54"	\$447	\$508	\$570	\$600	\$630	\$802	\$921	\$1,100	\$1,259	
	60"	\$466	\$540	\$597	\$638	\$664	\$847	\$976	\$1,165	\$1,332	
	66"	\$486	\$557	\$627	\$663	\$701	\$948	\$1,069	\$1,258	\$1,437	
	72"	\$508	\$573	\$639	\$690	\$738	\$989	\$1,138	\$1,351	\$1,540	
	78"	\$524	\$597	\$668	\$773	\$794	\$1,036	\$1,195	\$1,419	\$1,619	
	84"	\$548	\$622	\$696	\$811	\$849	\$1,085	\$1,252	\$1,482	\$1,699	
	96"	\$590	\$674	\$756	\$819	\$923	\$1,233	\$1,425	\$1,690	\$1,930	
	108"	\$650	\$745	\$838	\$909	\$1,024	\$1,369	\$1,586	\$1,881	\$2,150	
VALANCE ONLY		18"	\$246	\$259	\$291	\$312	\$331	\$420	\$491	\$595	\$703

PRICE GROUP F		24"	30"	36"	42"	48"	60"	72"	84"	96"	
Aires White Mykonos Dunes Navarre White Sand Prairie Snow Seaside White	36"	\$467	\$515	\$566	\$596	\$654	\$820	\$934	\$1,131	\$1,279	
	48"	\$506	\$571	\$635	\$676	\$717	\$927	\$1,058	\$1,275	\$1,477	
	54"	\$532	\$603	\$674	\$721	\$766	\$972	\$1,147	\$1,374	\$1,550	
	60"	\$560	\$635	\$708	\$762	\$827	\$1,046	\$1,203	\$1,434	\$1,656	
	66"	\$588	\$665	\$743	\$799	\$878	\$1,119	\$1,293	\$1,537	\$1,761	
	72"	\$611	\$695	\$777	\$837	\$921	\$1,205	\$1,392	\$1,654	\$1,890	
	78"	\$639	\$728	\$816	\$893	\$992	\$1,267	\$1,463	\$1,740	\$1,993	
	84"	\$663	\$758	\$852	\$949	\$1,044	\$1,327	\$1,536	\$1,823	\$2,094	
	96"	\$713	\$820	\$923	\$1,029	\$1,151	\$1,489	\$1,745	\$2,047	\$2,333	
	108"	\$790	\$910	\$1,024	\$1,145	\$1,283	\$1,658	\$1,945	\$2,282	\$2,604	
VALANCE ONLY		18"	\$289	\$327	\$368	\$392	\$439	\$543	\$635	\$774	\$893

SHADE SURCHARGE OPTION PRICING

Add any applicable surcharges to the retail price of the basic shade.

WIDTH

		WIDTH									
		24"	30"	36"	42"	48"	60"	72"	84"	96"	
PRIVACY LINER Privacy Beige Privacy Chocolate Privacy White Privacy Liners are the same color on both sides	LENGTH	36"	\$34	\$44	\$52	\$60	\$70	\$86	\$104	\$122	\$139
		48"	\$45	\$56	\$67	\$78	\$89	\$112	\$134	\$156	\$179
		54"	\$49	\$61	\$74	\$86	\$100	\$124	\$149	\$173	\$198
		60"	\$55	\$68	\$82	\$96	\$109	\$137	\$164	\$191	\$218
		66"	\$60	\$74	\$89	\$104	\$119	\$149	\$179	\$208	\$238
		72"	\$64	\$81	\$97	\$113	\$128	\$161	\$193	\$225	\$258
		78"	\$70	\$86	\$104	\$122	\$139	\$173	\$208	\$243	\$277
		84"	\$74	\$93	\$112	\$130	\$149	\$186	\$223	\$259	\$298
		96"	\$85	\$105	\$127	\$147	\$168	\$210	\$253	\$295	\$337
		108"	\$94	\$117	\$141	\$165	\$188	\$235	\$283	\$329	\$377

		WIDTH									
		24"	30"	36"	42"	48"	60"	72"	84"	96"	
BLACK-OUT LINER Black-Out Beige Black-Out Chocolate Black-Out White Black-Out Liners are off-white to the street	LENGTH	36"	\$37	\$45	\$55	\$64	\$72	\$91	\$109	\$127	\$146
		48"	\$46	\$59	\$70	\$82	\$94	\$117	\$141	\$164	\$187
		54"	\$52	\$66	\$78	\$91	\$104	\$130	\$156	\$182	\$209
		60"	\$57	\$71	\$86	\$100	\$115	\$143	\$172	\$201	\$229
		66"	\$63	\$78	\$94	\$109	\$126	\$156	\$187	\$218	\$250
		72"	\$68	\$85	\$101	\$119	\$135	\$169	\$203	\$238	\$270
		78"	\$72	\$91	\$109	\$127	\$146	\$182	\$218	\$255	\$292
		84"	\$78	\$98	\$117	\$137	\$156	\$195	\$235	\$273	\$313
		96"	\$89	\$111	\$132	\$154	\$178	\$221	\$266	\$310	\$354
		108"	\$98	\$124	\$149	\$173	\$198	\$247	\$296	\$347	\$396

		WIDTH									
		24"	30"	36"	42"	48"	60"	72"	84"	96"	
NARROW EDGE BINDING Beige Black Chocolate Copper Cream Desert Sand Light Beige Natural Sienna White	LENGTH	36"	\$38	\$40	\$42	\$44	\$46	\$51	\$55	\$59	\$63
		48"	\$46	\$48	\$51	\$52	\$55	\$59	\$63	\$67	\$71
		54"	\$51	\$52	\$55	\$56	\$59	\$63	\$67	\$71	\$75
		60"	\$55	\$56	\$59	\$60	\$63	\$67	\$71	\$75	\$79
		66"	\$59	\$60	\$63	\$64	\$67	\$71	\$75	\$79	\$83
		72"	\$63	\$64	\$67	\$68	\$71	\$75	\$79	\$83	\$87
		78"	\$67	\$68	\$71	\$72	\$75	\$79	\$83	\$87	\$91
		84"	\$71	\$72	\$75	\$78	\$79	\$83	\$87	\$91	\$96
		96"	\$79	\$82	\$83	\$86	\$87	\$91	\$96	\$100	\$104
		108"	\$87	\$90	\$91	\$94	\$96	\$100	\$104	\$108	\$113

		WIDTH									
		24"	30"	36"	42"	48"	60"	72"	84"	96"	
WIDE EDGE BINDING Beige Black Chocolate Copper Cream Desert Sand Light Beige Natural Sienna White	LENGTH	36"	\$49	\$52	\$55	\$57	\$60	\$66	\$71	\$76	\$82
		48"	\$60	\$63	\$66	\$68	\$71	\$76	\$82	\$87	\$93
		54"	\$66	\$68	\$71	\$74	\$76	\$82	\$87	\$93	\$98
		60"	\$71	\$74	\$76	\$79	\$82	\$87	\$93	\$98	\$104
		66"	\$76	\$79	\$82	\$85	\$87	\$93	\$98	\$104	\$109
		72"	\$82	\$85	\$87	\$90	\$93	\$98	\$104	\$109	\$115
		78"	\$87	\$90	\$93	\$96	\$98	\$104	\$109	\$115	\$120
		84"	\$93	\$96	\$98	\$101	\$104	\$109	\$115	\$120	\$126
		96"	\$104	\$107	\$109	\$112	\$115	\$120	\$126	\$131	\$137
		108"	\$115	\$117	\$120	\$123	\$126	\$131	\$137	\$142	\$147

SHADE SURCHARGE OPTION PRICING

Add any applicable surcharges to the retail price of the basic shade.

VALANCE ONLY SURCHARGES

LINER SURCHARGE: **\$38**

EDGE BINDING SURCHARGE: **\$23**

STYLE OPTIONS

MULTIPLE SHADES ON ONE HEAD RAIL
Add surcharge to price of two/three individual shades:

2-on-1: **\$52** surcharge

3-on-1: **\$65** surcharge

TWIN SHADE (movable liner): **\$309** surcharge
Add surcharge to price of shade with liner.

FABRIC VALANCE RETURNS: \$39
Made of edge binding material.

STAINLESS STEEL CHAIN: \$37

CUT OUTS: \$39 each cut out

WAND CONTROL SHADES

WAND CONTROL MOTOR: **\$235** (includes Wand)

WAND CONTROL BATTERY CHARGER

Chargers are not included with motorized shades; please identify desired quantity when placing order.

USB WAND CHARGER: **\$65**



White, beige, gray, bronze, or black wands

REMOTE CONTROL SHADES

REMOTE CONTROL MOTOR (LI, DC, AND AC STYLES): **\$350**

POWER LIFT MOTOR: **\$599**

CONTROLS

SINGLE-CHANNEL REMOTE: **\$71**

MULTI-CHANNEL REMOTE: **\$90**



Single-Channel Remote



Multi-Channel Remote

SINGLE-CHANNEL SWITCH: **\$126**

MULTI-CHANNEL SWITCH: **\$161**



Single-Channel Switch



Multi-Channel Switch

PRO HUB: **\$458**



Pro Hub

REMOTE CONTROL BATTERY CHARGERS

Chargers are not included with motorized shades; please identify desired quantity when placing order.

USB REMOTE CHARGER (w/6 ft cable): **\$65**

USB REMOTE CHARGER (w/16½ ft cable): **\$81**

RECHARGEABLE LITHIUM ION BATTERY PACK (Powers DC Motor): **\$120**

FOLDING DOOR PRICING – ONE WAY OPENING

All tracks and valance boards over 90" wide will be spliced to avoid oversize freight charges.

5% FULLNESS

WIDTH

PRICE GROUP A Devon Sunshade Brown Penang	LENGTH	48"	60"	72"	84"	96"	120"	132"	144"	156"	168"	180"	192"
		48"	\$382	\$450	\$515	\$596	\$675	\$826	\$902	\$978	\$1,054	\$1,130	\$1,206
60"	\$426	\$504	\$579	\$669	\$758	\$929	\$1,015	\$1,101	\$1,187	\$1,273	\$1,359	\$1,444	
72"	\$470	\$557	\$642	\$742	\$841	\$1,033	\$1,129	\$1,224	\$1,320	\$1,415	\$1,511	\$1,606	
84"	\$514	\$611	\$706	\$815	\$923	\$1,137	\$1,244	\$1,350	\$1,457	\$1,564	\$1,671	\$1,778	
96"	\$558	\$665	\$769	\$888	\$1,006	\$1,240	\$1,359	\$1,477	\$1,595	\$1,713	\$1,831	\$1,950	
Valance		\$114	\$118	\$150	\$153	\$190	\$236	\$253	\$269	\$285	\$301	\$317	\$334

PRICE GROUP B Driftwood Alder Bora Bora Barcelona Tamarind Bamboo Forest Java	LENGTH	48"	60"	72"	84"	96"	120"	132"	144"	156"	168"	180"	192"
		48"	\$406	\$480	\$552	\$638	\$723	\$887	\$968	\$1,048	\$1,129	\$1,210	\$1,291
60"	\$456	\$542	\$624	\$722	\$818	\$1,005	\$1,099	\$1,193	\$1,287	\$1,381	\$1,475	\$1,569	
72"	\$507	\$603	\$697	\$806	\$913	\$1,124	\$1,229	\$1,335	\$1,440	\$1,545	\$1,651	\$1,756	
84"	\$557	\$665	\$769	\$890	\$1,008	\$1,243	\$1,360	\$1,476	\$1,593	\$1,709	\$1,826	\$1,943	
96"	\$607	\$726	\$842	\$973	\$1,104	\$1,362	\$1,491	\$1,621	\$1,750	\$1,880	\$2,010	\$2,139	
Valance		\$127	\$132	\$167	\$172	\$214	\$267	\$287	\$306	\$326	\$345	\$364	\$384

PRICE GROUP C Sunshade White Aspen Mandalay	LENGTH	48"	60"	72"	84"	96"	120"	132"	144"	156"	168"	180"	192"
		48"	\$448	\$532	\$614	\$711	\$807	\$991	\$1,080	\$1,169	\$1,258	\$1,347	\$1,436
60"	\$508	\$607	\$702	\$813	\$923	\$1,136	\$1,241	\$1,346	\$1,452	\$1,557	\$1,662	\$1,767	
72"	\$569	\$681	\$791	\$915	\$1,039	\$1,281	\$1,402	\$1,524	\$1,645	\$1,766	\$1,888	\$2,009	
84"	\$630	\$756	\$879	\$1,017	\$1,154	\$1,425	\$1,560	\$1,694	\$1,829	\$1,963	\$2,098	\$2,232	
96"	\$690	\$830	\$967	\$1,119	\$1,270	\$1,570	\$1,721	\$1,872	\$2,022	\$2,173	\$2,323	\$2,474	
Valance		\$147	\$156	\$194	\$203	\$252	\$298	\$321	\$343	\$366	\$389	\$411	\$434

PRICE GROUP D Telluride	LENGTH	48"	60"	72"	84"	96"	120"	132"	144"	156"	168"	180"	192"
		48"	\$530	\$631	\$727	\$842	\$955	\$1,173	\$1,279	\$1,384	\$1,490	\$1,595	\$1,701
60"	\$602	\$719	\$832	\$963	\$1,093	\$1,345	\$1,470	\$1,594	\$1,719	\$1,844	\$1,969	\$2,093	
72"	\$674	\$807	\$936	\$1,084	\$1,230	\$1,517	\$1,661	\$1,804	\$1,948	\$2,092	\$2,236	\$2,380	
84"	\$746	\$895	\$1,041	\$1,205	\$1,367	\$1,688	\$1,847	\$2,007	\$2,166	\$2,325	\$2,484	\$2,644	
96"	\$818	\$983	\$1,145	\$1,326	\$1,505	\$1,860	\$2,038	\$2,217	\$2,395	\$2,573	\$2,752	\$2,930	
Valance		\$174	\$184	\$230	\$240	\$298	\$353	\$380	\$407	\$434	\$460	\$487	\$514

FOLDING DOOR SURCHARGE PRICING

5% FULLNESS

WIDTH

LIGHT-FILTERING LINER Privacy Beige Privacy Chocolate Privacy White	LENGTH	48"	60"	72"	84"	96"	120"	132"	144"	156"	168"	180"	192"
		48"	\$122	\$144	\$165	\$191	\$217	\$266	\$290	\$315	\$339	\$363	\$387
60"	\$137	\$163	\$187	\$217	\$246	\$302	\$330	\$358	\$386	\$414	\$442	\$471	
72"	\$152	\$181	\$209	\$242	\$274	\$337	\$369	\$400	\$432	\$464	\$495	\$527	
84"	\$167	\$199	\$231	\$267	\$303	\$373	\$408	\$443	\$478	\$513	\$548	\$583	
96"	\$182	\$218	\$253	\$292	\$331	\$409	\$447	\$486	\$525	\$564	\$603	\$642	
Valance*		\$38	\$40	\$50	\$52	\$64	\$80	\$86	\$92	\$98	\$103	\$109	\$115

Light-filtering liners are the same color on both sides

*If folding door is ordered with a liner, there will be no additional lined valance surcharge.

BLACK-OUT LINER Black-Out Beige Black-Out Chocolate Black-Out White	LENGTH	48"	60"	72"	84"	96"	120"	132"	144"	156"	168"	180"	192"
		48"	\$162	\$192	\$221	\$255	\$289	\$355	\$387	\$419	\$452	\$484	\$517
60"	\$183	\$217	\$250	\$289	\$327	\$402	\$440	\$477	\$515	\$552	\$590	\$628	
72"	\$203	\$241	\$279	\$322	\$365	\$450	\$492	\$534	\$576	\$618	\$660	\$702	
84"	\$223	\$266	\$308	\$356	\$403	\$497	\$544	\$590	\$637	\$684	\$730	\$777	
96"	\$243	\$290	\$337	\$389	\$441	\$545	\$597	\$648	\$700	\$752	\$804	\$856	
Valance*		\$51	\$53	\$67	\$69	\$85	\$107	\$115	\$122	\$130	\$138	\$146	\$154

Black-out liners are off-white to the street

*If folding door is ordered with a liner, there will be no additional lined valance surcharge.

20% FULLNESS: **Add 20%**

SPLIT DRAW (CENTER-OPENING): **\$157**

NET FREIGHT SURCHARGE:

UP TO 93" LONG: **\$40**

OVER 93" LONG: **\$100**

SLIDING PANEL PRICING GROUPS A - D

All tracks and valance boards over 90" wide will be spliced to avoid oversize freight charges

WIDTH

PRICE GROUP A Devon Penang Oak Sunshade Brown	LENGTH	60"	72"	84"	96"	108"	120"	132"	144"	156"	168"	180"	192"
		60"	\$659	\$742	\$831	\$941	\$1,024	\$1,113	\$1,202	\$1,279	\$1,386	\$1,493	\$1,599
72"	\$713	\$804	\$902	\$1,025	\$1,116	\$1,214	\$1,314	\$1,400	\$1,517	\$1,634	\$1,751	\$1,867	
84"	\$767	\$867	\$974	\$1,108	\$1,208	\$1,315	\$1,427	\$1,521	\$1,648	\$1,775	\$1,902	\$2,029	
96"	\$822	\$930	\$1,045	\$1,192	\$1,300	\$1,415	\$1,539	\$1,642	\$1,779	\$1,916	\$2,053	\$2,190	
108"	\$925	\$1,046	\$1,176	\$1,341	\$1,463	\$1,592	\$1,732	\$1,848	\$2,002	\$2,156	\$2,310	\$2,464	
120"	\$1,027	\$1,163	\$1,306	\$1,490	\$1,625	\$1,769	\$1,924	\$2,053	\$2,224	\$2,395	\$2,566	\$2,737	
Valance		\$47	\$56	\$66	\$75	\$85	\$94	\$104	\$113	\$122	\$132	\$141	\$151

PRICE GROUP B Alder Bamboo Forest Barcelona Café Bora Bora Driftwood Natural Java Cocoa Tamarind Sunset	LENGTH	60"	72"	84"	96"	108"	120"	132"	144"	156"	168"	180"	192"
		60"	\$673	\$759	\$851	\$964	\$1,049	\$1,141	\$1,232	\$1,313	\$1,422	\$1,532	\$1,641
72"	\$731	\$825	\$926	\$1,052	\$1,147	\$1,248	\$1,351	\$1,441	\$1,561	\$1,681	\$1,801	\$1,921	
84"	\$788	\$891	\$1,001	\$1,140	\$1,244	\$1,354	\$1,470	\$1,568	\$1,699	\$1,830	\$1,960	\$2,091	
96"	\$845	\$958	\$1,077	\$1,229	\$1,341	\$1,460	\$1,588	\$1,696	\$1,837	\$1,978	\$2,120	\$2,261	
108"	\$951	\$1,077	\$1,211	\$1,382	\$1,509	\$1,643	\$1,787	\$1,908	\$2,067	\$2,226	\$2,385	\$2,544	
120"	\$1,057	\$1,197	\$1,346	\$1,536	\$1,677	\$1,825	\$1,985	\$2,120	\$2,296	\$2,473	\$2,650	\$2,826	
Valance		\$49	\$59	\$69	\$79	\$89	\$99	\$108	\$118	\$128	\$138	\$148	\$158

PRICE GROUP C Aspen Mandalay Umber Sakura Oregon Savanna Husk Sunshade White	LENGTH	60"	72"	84"	96"	108"	120"	132"	144"	156"	168"	180"	192"
		60"	\$686	\$774	\$869	\$984	\$1,072	\$1,166	\$1,260	\$1,343	\$1,454	\$1,566	\$1,678
72"	\$746	\$844	\$947	\$1,077	\$1,174	\$1,278	\$1,384	\$1,476	\$1,599	\$1,722	\$1,845	\$1,968	
84"	\$806	\$913	\$1,026	\$1,169	\$1,276	\$1,389	\$1,508	\$1,610	\$1,744	\$1,878	\$2,012	\$2,146	
96"	\$866	\$982	\$1,105	\$1,262	\$1,378	\$1,500	\$1,632	\$1,743	\$1,889	\$2,034	\$2,179	\$2,324	
108"	\$974	\$1,105	\$1,243	\$1,419	\$1,550	\$1,688	\$1,836	\$1,961	\$2,125	\$2,288	\$2,452	\$2,615	
120"	\$1,083	\$1,228	\$1,381	\$1,577	\$1,722	\$1,876	\$2,040	\$2,179	\$2,361	\$2,542	\$2,724	\$2,906	
Valance		\$51	\$62	\$72	\$82	\$92	\$103	\$113	\$123	\$133	\$144	\$154	\$164

PRICE GROUP D Capri Natural Telluride	LENGTH	60"	72"	84"	96"	108"	120"	132"	144"	156"	168"	180"	192"
		60"	\$730	\$826	\$928	\$1,053	\$1,149	\$1,251	\$1,352	\$1,443	\$1,563	\$1,683	\$1,803
72"	\$799	\$906	\$1,019	\$1,159	\$1,266	\$1,379	\$1,495	\$1,596	\$1,729	\$1,862	\$1,995	\$2,128	
84"	\$868	\$985	\$1,109	\$1,266	\$1,383	\$1,507	\$1,637	\$1,750	\$1,896	\$2,042	\$2,187	\$2,333	
96"	\$936	\$1,065	\$1,200	\$1,372	\$1,500	\$1,636	\$1,780	\$1,904	\$2,062	\$2,221	\$2,379	\$2,538	
108"	\$1,053	\$1,198	\$1,350	\$1,543	\$1,688	\$1,840	\$2,002	\$2,141	\$2,320	\$2,498	\$2,677	\$2,855	
120"	\$1,170	\$1,331	\$1,500	\$1,715	\$1,876	\$2,045	\$2,225	\$2,379	\$2,578	\$2,776	\$2,974	\$3,173	
Valance		\$58	\$70	\$81	\$93	\$104	\$116	\$128	\$139	\$151	\$162	\$174	\$186

SLIDING PANEL PRICING GROUPS E - F

All tracks and valance boards over 90" wide will be spliced to avoid oversize freight charges

		WIDTH												
PRICE GROUP E		60"	72"	84"	96"	108"	120"	132"	144"	156"	168"	180"	192"	
Artisan Weave Catalina Natural Jute Orleans Macaroon Prairie Golden Prairie White Remi Breeze Saybrook Stone	LENGTH	60"	\$824	\$932	\$1,047	\$1,188	\$1,296	\$1,411	\$1,525	\$1,627	\$1,763	\$1,899	\$2,034	\$2,170
		72"	\$901	\$1,021	\$1,149	\$1,308	\$1,428	\$1,556	\$1,686	\$1,801	\$1,951	\$2,101	\$2,251	\$2,401
		84"	\$979	\$1,111	\$1,251	\$1,428	\$1,560	\$1,700	\$1,847	\$1,974	\$2,138	\$2,303	\$2,467	\$2,632
		96"	\$1,056	\$1,201	\$1,354	\$1,547	\$1,692	\$1,845	\$2,008	\$2,147	\$2,326	\$2,505	\$2,684	\$2,863
		108"	\$1,188	\$1,351	\$1,523	\$1,741	\$1,904	\$2,076	\$2,259	\$2,416	\$2,617	\$2,818	\$3,019	\$3,221
		120"	\$1,320	\$1,502	\$1,692	\$1,934	\$2,116	\$2,306	\$2,510	\$2,684	\$2,908	\$3,131	\$3,355	\$3,579
		Valance	\$66	\$79	\$92	\$105	\$118	\$131	\$144	\$157	\$170	\$183	\$197	\$210

		WIDTH												
PRICE GROUP F		60"	72"	84"	96"	108"	120"	132"	144"	156"	168"	180"	192"	
Aires White Mykonos Dunes Navarre White Sand Prairie Snow Seaside White	LENGTH	60"	\$1,112	\$1,258	\$1,413	\$1,604	\$1,749	\$1,905	\$2,059	\$2,197	\$2,380	\$2,563	\$2,746	\$2,929
		72"	\$1,217	\$1,379	\$1,551	\$1,765	\$1,928	\$2,100	\$2,276	\$2,431	\$2,633	\$2,836	\$3,039	\$3,241
		84"	\$1,321	\$1,500	\$1,689	\$1,927	\$2,106	\$2,296	\$2,493	\$2,665	\$2,887	\$3,109	\$3,331	\$3,553
		96"	\$1,426	\$1,622	\$1,828	\$2,089	\$2,285	\$2,491	\$2,710	\$2,899	\$3,140	\$3,382	\$3,623	\$3,865
		108"	\$1,604	\$1,824	\$2,056	\$2,350	\$2,570	\$2,802	\$3,049	\$3,261	\$3,533	\$3,805	\$4,076	\$4,348
		120"	\$1,782	\$2,027	\$2,284	\$2,611	\$2,856	\$3,114	\$3,388	\$3,623	\$3,925	\$4,227	\$4,529	\$4,831
Valance	\$88	\$106	\$124	\$142	\$159	\$177	\$195	\$212	\$230	\$248	\$265	\$283		

SLIDING PANEL OPTION PRICING

		WIDTH												
PRIVACY LINER		60"	72"	84"	96"	108"	120"	132"	144"	156"	168"	180"	192"	
Privacy Beige Privacy Chocolate Privacy White Privacy Liners are the same color on both sides	LENGTH	60"	\$202	\$228	\$255	\$289	\$315	\$342	\$370	\$394	\$427	\$460	\$492	\$525
		72"	\$219	\$248	\$278	\$316	\$344	\$374	\$405	\$432	\$468	\$504	\$540	\$576
		84"	\$236	\$267	\$300	\$342	\$373	\$406	\$441	\$470	\$510	\$549	\$588	\$627
		96"	\$254	\$287	\$323	\$369	\$402	\$438	\$477	\$509	\$551	\$594	\$636	\$678
		108"	\$285	\$323	\$363	\$415	\$453	\$493	\$536	\$572	\$620	\$668	\$715	\$763
		120"	\$317	\$359	\$404	\$461	\$503	\$548	\$596	\$636	\$689	\$742	\$795	\$848
Valance	\$15	\$18	\$21	\$24	\$27	\$30	\$33	\$35	\$38	\$41	\$44	\$47		

		WIDTH												
BLACK-OUT LINER		60"	72"	84"	96"	108"	120"	132"	144"	156"	168"	180"	192"	
Black-Out Beige Black-Out Chocolate Black-Out White Black-Out Liners are off-white to the street	LENGTH	60"	\$269	\$304	\$340	\$385	\$420	\$457	\$493	\$525	\$569	\$613	\$656	\$700
		72"	\$292	\$330	\$370	\$421	\$459	\$499	\$540	\$576	\$624	\$672	\$720	\$768
		84"	\$315	\$357	\$401	\$456	\$498	\$542	\$588	\$627	\$680	\$732	\$784	\$836
		96"	\$338	\$383	\$431	\$492	\$537	\$584	\$635	\$678	\$735	\$791	\$848	\$904
		108"	\$380	\$431	\$485	\$553	\$604	\$657	\$715	\$763	\$827	\$890	\$954	\$1,018
		120"	\$423	\$479	\$538	\$614	\$671	\$730	\$794	\$848	\$919	\$989	\$1,060	\$1,131
Valance	\$20	\$24	\$28	\$32	\$35	\$39	\$43	\$47	\$51	\$55	\$59	\$63		

WIDE EDGE BINDING: **\$226**

NET FREIGHT SURCHARGE: **\$40**

WOVEN WOOD WARRANTY

LIMITED LIFETIME WARRANTY

This product is warranted against defects in materials and workmanship, provided that:

1. The product was installed according to the product instructions.
2. Manufacturer recommendations were followed regarding limitations and specifications of the product.

Manufacturer reserves the right to determine if your shade warrants a repair or partial replacement of any parts. If necessary, Manufacturer will replace your shade with a new shade of equal or superior value. This shall be your sole remedy under this warranty.

This Limited Lifetime Warranty excludes all motors, controls and accessories, which are warranted for only a period of five years from the date of purchase. Failure to follow the proper installation, charging and use instructions will invalidate the warranty for motors, remotes, wands and hubs.

This Limited Lifetime Warranty applies only to the original retail purchaser with proof of purchase.

This Limited Lifetime Warranty does not cover the removal or installation of original or replacement shades. This Limited Lifetime Warranty does not cover damage or defects caused by, or resulting from improper maintenance, neglect or improper use, wear and tear, abuse, neglect, accidents, alteration, commercial use, installation, removal or reinstallation or exposure to excessive moisture.

YOUR RIGHTS UNDER STATE LAW

These warranties give you specific legal rights. You may also have other rights which may vary from State to State. In no event shall the Manufacturer be liable for incidental or consequential damages or for any other direct or indirect damage, loss, cost, expense or fee. Some states do not allow the exclusion or limitation of incidental or consequential damages, so the above limitation or exclusion may not apply to you. These warranties are exclusive and in lieu of all other obligations, liabilities, disclaimers, or warranties.

WALDEN PREMIER

⚠️ WARNING

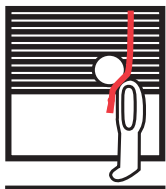

Window Blind Cord Strangulation Risk

Window blinds with a damaged or loose tension device or retractable cord that fails to fully retract pose a strangulation risk to children. To avoid this potential strangulation risk, consider purchasing cordless products with inaccessible cords.

ANSIWOMA A100.1-2022

⚠️ ADVERTENCIA

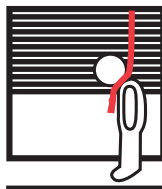

Riesgo de Estrangulamiento en Cuerdas de Persianas

Las persianas con un dispositivo tensor suelto o dañado o con una cuerda retráctable que no se ajusta completamente representan un riesgo de estrangulación para los niños. Para evitar un posible riesgo de estrangulamiento, considere comprar productos inalámbricos o productos con cuerdas inaccesibles.

ANSIWOMA A100.1-2022



Office: 972-564-0037

E-Mail: customerservice@lonestarshutters.com

Website: www.lonestarshutters.com