

2024 Product Guide



**LONE STAR SHUTTERS**

**Blinds & Shades**

**WALDEN**  
SELECT



## ABOUT THE COLLECTION

The Walden Select Collection includes contemporary patterns, with bamboos that have been re-imagined for modern decor, woven jutes in trending gray and white color choices, and soft, natural fabrics.

Using natural shades in your design is a subtle way to bring the timeless beauty of nature into your space.

Shades incorporate natural fibers like bamboo, jute, and ramie into their weaves, which are selected based on color and luster. Materials are hand processed and woven into shade fabric. Finished fabrics highlight the textures, colors, and qualities of the natural materials used to create them.

After drying and quality review, fabrics are then sewn and constructed by hand into finished shades.

All the patterns in the collection can be made into roman shades or sliding panels. Many can be made into folding doors.

Natural shades are as functional as they are beautiful with several customization options including the ability to tailor your light and privacy preferences with various liner and shade styles.

The collection has three unique cord-free control options: our patented cordless system that can lift even the heaviest shade on a 1½" head rail and our affordable, versatile wand and remote control motorization options.

Our Limited Lifetime Warranty covers all aspects of workmanship and quality in your shades.

# TABLE OF CONTENTS

## MATERIALS REFERENCE TABLES

<a href="#">Woven Wood Materials Reference</a>	4 - 5
<a href="#">Edge Binding / Liner Materials Reference</a>	5

## SHADE CONSTRUCTION

<a href="#">Shade Styles</a>	6
<a href="#">Shade Options</a>	7

## SHADE CONTROL OPTIONS

<a href="#">Cordless</a>	8
<a href="#">Clutch</a>	8
<a href="#">Wand Motor</a>	9
<a href="#">Remote Motor</a>	10

## ADDITIONAL OPTIONS

<a href="#">Valances</a>	11
<a href="#">Edge Binding</a>	11
<a href="#">Cut Outs</a>	12
<a href="#">Hold Down Brackets</a>	12
<a href="#">Valance Only</a>	12

## SHADE SPECIFICATIONS

<a href="#">Specifications Table</a>	13
<a href="#">Specification Line Drawings</a>	14

## FOLDING DOORS

<a href="#">Options</a>	15 - 16
<a href="#">Specifications</a>	17

## SLIDING PANELS

<a href="#">Options</a>	18
<a href="#">Specifications</a>	19 - 20
<a href="#">Configurations</a>	21

## PRICING

<a href="#">Shade Price Grids</a>	22 - 23
<a href="#">Shade Option Pricing</a>	24 - 25
<a href="#">Folding Door Pricing</a>	26 - 27
<a href="#">Sliding Panel Pricing</a>	28 - 30

## WARRANTY

<a href="#">Limited Lifetime Warranty</a>	32
---	----



# MATERIALS REFERENCE

PATTERN CODE	PATTERN NAME	PRICE GROUP	MATERIAL CONTENT	FOLDING DOOR	SLIDING PANEL	COORDINATED EDGE BINDING COLOR	COORDINATED WAND COLOR
WS-F132	Alisia Antique White <sup>[1]</sup>	E	60% Bamboo, 40% Cotton-Polyester Yarn	Y	Y	Wheat	Beige
WS-F111	Alisia Chiffon <sup>[1]</sup>	E	60% Bamboo, 40% Cotton-Polyester Yarn	Y	Y	Pearl	White
WS-F122	Alisia Morning <sup>[1]</sup>	E	60% Bamboo, 40% Cotton-Polyester Yarn	Y	Y	Titanium	Gray
WS-V043	Andros Birch	E	70% Bark, 30% Bamboo	Y	Y	Stone	Beige
WS-V049	Andros Harbor	E	70% Bark, 30% Bamboo	Y	Y	Titanium	Gray
WS-1922	Antilles Mist	D	60% Jute, 40% Bamboo	N	Y	Olive	Beige
WS-1903	Antilles Sand	D	60% Jute, 40% Bamboo	N	Y	Wheat	Beige
WS-1905	Antilles Seagrass	D	60% Jute, 40% Bamboo	N	Y	Wheat	Beige
WS-5322	Cala Platinum	B	100% Bamboo	Y	Y	Titanium	Gray
WS-5302	Cala Titanium	B	100% Bamboo	Y	Y	Titanium	Gray
WS-0390	Camden Natural <sup>[2]</sup>	D	100% Ramie	N	Y	Wheat	Beige
WS-0392	Camden Snow <sup>[2]</sup>	D	100% Ramie	N	Y	Pearl	White
WS-W116	Chelsea Lace	D	40% Bamboo, 40% Flax, 20% Paper	Y	Y	Pearl	White
WS-W118	Chelsea Taupe	D	40% Bamboo, 40% Flax, 20% Paper	Y	Y	Stone	Gray
WS-1322	Como Charcoal <sup>[1]</sup>	E	80% Flax, 20% Bamboo	N	Y	Stone	Beige
WS-1302	Como Ecrú <sup>[1]</sup>	E	80% Flax, 20% Bamboo	N	Y	Wheat	Beige
WS-1323	Como Gray <sup>[1]</sup>	E	80% Flax, 20% Bamboo	N	Y	Wheat	Beige
WS-1388	Como Midnight <sup>[1]</sup>	E	80% Flax, 20% Bamboo	N	Y	Onyx	Black
WS-1303	Como Umber <sup>[1]</sup>	E	80% Flax, 20% Bamboo	N	Y	Wheat	Beige
WS-A904	Fay Black <sup>[1]</sup>	E	100% Bamboo	Y	Y	Onyx	Black
WS-A133	Fay Snow <sup>[1]</sup>	E	100% Bamboo	Y	Y	Pearl	White
WS-D601	Fay Tan <sup>[1]</sup>	E	90% Bamboo, 10% Cotton-Polyester Yarn	Y	Y	Camel	Beige
WS-0389	Halifax Natural <sup>[2]</sup>	D	100% Jute	N	Y	Wheat	Beige
WS-0427	Harbor Golden	D	100% Ramie	N	Y	Wheat	Beige
WS-0428	Harbor White	D	100% Ramie	N	Y	Wheat	Beige
WS-E402	Lou Coconut	C	60% Paper, 40% Bamboo	Y	Y	Pearl	White
WS-E302	Lou Contrast	C	50% Bamboo, 50% Paper	Y	Y	Onyx	Black
WS-E401	Lou Cotton	C	60% Paper, 40% Bamboo	Y	Y	Pearl	White
WS-E501	Lou Driftwood	C	60% Paper, 40% Bamboo	Y	Y	Titanium	Gray
WS-0702	Malvern Chalk	B	100% Bamboo	Y	Y	Pearl	White
WS-0722	Malvern Gray	B	100% Bamboo	Y	Y	Titanium	Gray
WS-0721	Malvern Light Gray	B	100% Bamboo	Y	Y	Titanium	Gray
WS-0723	Malvern Platinum	B	100% Bamboo	Y	Y	Titanium	Gray
WS-0812	Metro Caramel	C	100% Bamboo	Y	Y	Camel	Bronze
WS-0802	Metro Chalk	C	100% Bamboo	Y	Y	Pearl	White

All fabrics have a maximum width of 96".

<sup>[1]</sup> Edge Binding is required. Patterns that require edge binding have the cost of edge binding included in the base price of the shade.

<sup>[2]</sup> Edge Binding is recommended.

# MATERIALS REFERENCE

PATTERN CODE	PATTERN NAME	PRICE GROUP	MATERIAL CONTENT	FOLDING DOOR	SLIDING PANEL	COORDINATED EDGE BINDING COLOR	COORDINATED WAND COLOR
WS-0822	Metro Smoke	C	100% Bamboo	Y	Y	Wheat	Beige
WS-1806	Montana Inkwash	D	50% Jute, 50% Ramie	N	Y	Onyx	Black
WS-1888	Montana Mineral	D	50% Jute, 50% Ramie	N	Y	Onyx	Black
WS-1605	Nantucket Sea Mist	D	100% Jute	N	Y	Wheat	Beige
WS-0522	Osaka Granite	B	100% Bamboo	Y	Y	Titanium	Gray
WS-0502	Osaka Snow	B	100% Bamboo	Y	Y	Pearl	White
WS-1516	Parchment Husk <sup>[2]</sup>	D	100% Red Ramie	N	Y	Wheat	Beige
WS-1201	Peri Mist	E	60% Ramie, 40% Paper	N	Y	Titanium	Gray
WS-1517	Portland Inkwash <sup>[2]</sup>	D	100% Ramie	N	Y	Navy	Bronze
WS-1522	Portland Sky <sup>[2]</sup>	D	100% Ramie	N	Y	Wheat	Beige
WS-0602	Pudong White	A	100% Bamboo	Y	Y	Pearl	White
WS-1101	Selene Natural <sup>[1]</sup>	E	100% Ramie	N	Y	Wheat	Beige
WS-1102	Selene White <sup>[1]</sup>	E	100% Ramie	N	Y	Wheat	White
WS-0004	Soft Jute Beige <sup>[1]</sup>	F	100% Ramie	N	Y	Wheat	Beige
WS-0022	Soft Jute Gray <sup>[1]</sup>	F	100% Ramie	N	Y	Stone	Beige
WS-0001	Soft Jute White <sup>[1]</sup>	F	100% Ramie	N	Y	Wheat	Beige
WS-1504	Sonoma Dusk <sup>[2]</sup>	D	100% Ramie	N	Y	Camel	Bronze
WS-9077	Terra Oak	C	100% Jute	N	Y	Camel	Beige
WS-0833	Tortola Natural	D	90% Jute, 10% Bamboo	N	Y	Camel	Bronze
WS-0288	Umbria Ink	C	80% Bamboo, 20% Ramie	Y	Y	Onyx	Black
WS-0222	Umbria Mist	C	80% Bamboo, 20% Ramie	Y	Y	Stone	Beige
WS-0219	Umbria Sepia	C	80% Bamboo, 20% Ramie	Y	Y	Wheat	Bronze

All fabrics have a maximum width of 96".

<sup>[1]</sup> Edge Binding is required. Patterns that require edge binding have the cost of edge binding included in the base price of the shade.

<sup>[2]</sup> Edge Binding is recommended.

## RAMIE EDGE BINDINGS

COLOR NUMBER	COLOR	MATERIAL CONTENT
EB09	Camel	100% Ramie
EB78	Navy	100% Ramie
EB15	Olive	100% Ramie
EB10	Onyx	100% Ramie
EB62	Pearl	100% Ramie
EB105	Stone	100% Ramie
EB58	Titanium	100% Ramie
EB82	Wheat	100% Ramie

## LINERS

COLOR NUMBER	COLOR	MATERIAL CONTENT
LIGHT-FILTERING LINERS		
LF82	Beige	50% Cotton, 50% Polyester
LF10	Black*	100% Ramie
LF58	Gray	50% Cotton, 50% Polyester
LF62	Soft White	50% Cotton, 50% Polyester
BLACK-OUT LINERS		
BO03	Beige	100% Polyester
BO09	Espresso	100% Polyester
BO01	White	100% Polyester

Light-filtering liners are the same color on both sides. Black-out liners are off-white to the street.

\*Black liners wider than 53" will be seamed.

# SHADE STYLES

## FABRIC SELECTION

The fabrics in this collection are made from natural materials, which are subject to variation in color, texture, and weave. Like any wood or bamboo product, fabrics may show natural color changes over time.

Natural fabrics are not ideal for rooms with excessive humidity like bathrooms. Shades installed in these environments may bow or twist over time.

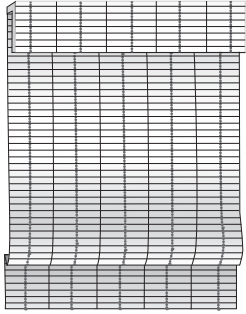

### STANDARD ROMAN SHADE

Shade material is attached to the back of the head rail. Shade includes a 6" valance to conceal the components. When raised, the material rises from the bottom in flat folds.

Shades operated by cord loop will have controls in front of the shade.

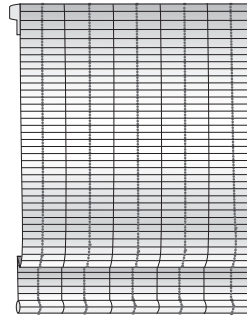

### WATERFALL SHADE

Shade material is attached to the front of the head rail, without a valance. When raised, the material rises from the bottom in flat folds. Optional back valance is available upon request.

Shades operated by cord loop will have controls behind the shade.

## VALANCE RETURNS

Outside mount shades are recommended to be ordered with valance returns. Returns for both outside and inside mount shades are available free of charge if requested at the time the order is placed.

Standard valance returns are made using the shade material. Valance returns can also be made using edge binding material upon request; this is a surcharge option.

Standard valance return height will be 1½" less than the valance height. This length will keep the rolled bottom of the valance from interfering with the return.

Optional short valance returns are also available. Short returns cover the end of the head rail and hide the components, keeping the stack of the raised shade away from the returns.

Custom valance return lengths are available to be ordered upon request.

All valance returns will be made with an L-shaped connector to attach to the back of the valance. This holds the returns in place and creates a clean, finished corner.

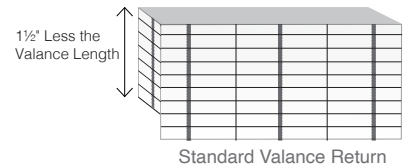

## BOTTOM BAR

Clutch and motorized shades will be made with a round bottom bar. Cordless shades are made with a rectangular bottom bar.

# SHADE OPTIONS

## LINERS

A liner can be ordered attached to the back of the shade or as a separate operable, movable liner (see Twin Shade below).

## ATTACHED LINERS

Attached liners are available in light-filtering or black-out. They are secured to the back of the shade by stitches at each side of the liner. If a shade is lined, the valance will automatically be lined with the same material.

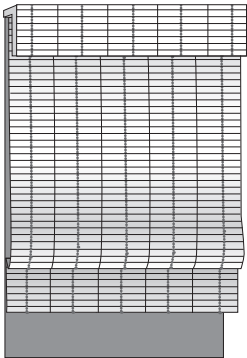

### TWIN SHADE

A twin shade features two separate, independently operated shades on one head rail. The front shade can be either a standard or waterfall natural woven shade.

A separate liner shade is attached to the back of the head rail and both shades operate independently.

Outside mount twin shades will be made with a valance that is  $\frac{3}{4}$ " wider than the ordered shade width. This will allow the returns to fit behind the valance.

See Specifications for head rail sizes.

Not available as 3-on-1 headrail.

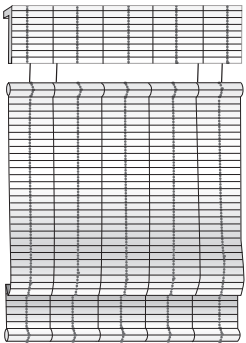

### TOP-DOWN BOTTOM-UP SHADES

Top-down bottom-up (TDBU) shades can be raised from the bottom or lowered from the top. To conceal shade components, shades will be finished with a lined valance.

Outside mount TDBU shades will be made with a valance that is  $\frac{3}{4}$ " wider than the ordered shade width, allowing the returns to fit behind the valance.

TDBU shades are not available in waterfall style, as multiple shades on one head rail, or as twin shades.

Only available with cordless control.

## MULTIPLE SHADES ON ONE HEAD RAIL

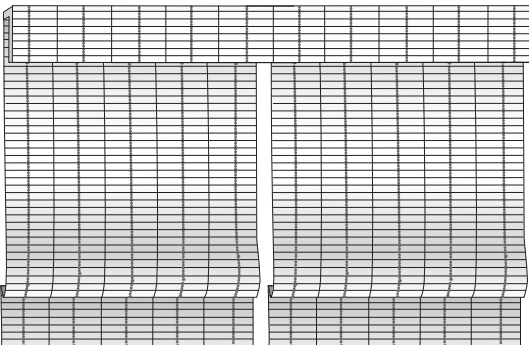

*shown with two shades*

Shades are available with 2-on-1 or 3-on-1 head rail. The maximum total width is 108" and the gap between shades will be no more than  $\frac{1}{2}$ ". The maximum width for a common valance is 96"; wider valances will be made in sections to match the individual shade widths.

Multiple shades on one head rail are available to be ordered with all control types except top-down bottom-up. Pay careful attention to make sure there are suitable locations for cord tensioners when specifying multiple shades on one head rail, particularly for the middle shade in 3-on-1 head rail units.

# SHADE CONTROL OPTIONS

## CORDLESS SHADES

Cordless shades operate with no lift cords on the front of the shade. The shade is lowered by pulling on the hem bar. A spring control system, located under the wooden head rail, holds the shade in place at any desired position.

Clear grips are added to the hem bar of cordless shades; one per shade up to 72" wide and two for wider shades.

Cordless shades are available up to 96" wide and 96" long and will be mounted on standard depth head rails (see Specifications for details).

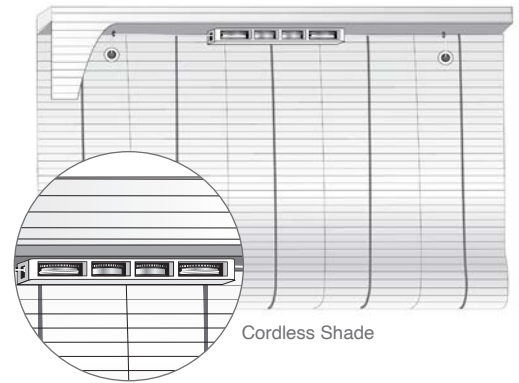

## CLUTCH CONTROLS

Clutches provide an assisted lift for large or heavy shades and come standard with color-coordinated cord loops available in one foot increments from 2' to 6'. The factory will choose the length closest to 2/3 the shade height, unless otherwise requested. Nickel-plated bead chain loops are available as a surcharge option and can be made to custom lengths.

Compliant cord tensioners are provided with clutch control shades. Cord tensioners secure the cord loop to the wall or window. They must be installed for the shade to be compliant with safety regulations and to operate properly.

Standard shades ordered with a clutch come "clutch adjacent" to keep the stack of the raised shade from interfering with the loop. This means the shade fabric will be narrower than the ordered width on the control side, allowing the cord to hang to the side of the shade (see diagram). This may cause a light gap on black-out shades.

Waterfall shades ordered with clutch controls will have control loops behind the shade and are not available to be ordered as clutch adjacent.

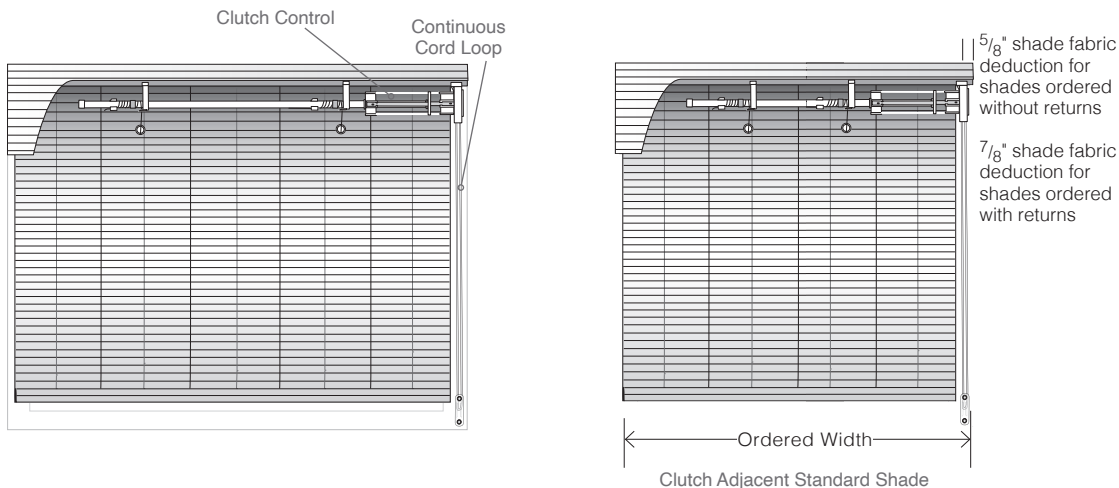



# SHADE CONTROL OPTIONS

## WAND CONTROL SHADES

Wand control motorized shades are powered by a rechargeable lithium-ion battery. The motor is controlled using a wand which hangs down to the side of the shade.

Waterfall shades are not available to be ordered with wand control.

Wands are available in 4 lengths: 24", 36", 48", and 60".  
Available colors include: white, beige, gray, bronze, and black.

Wand control shade motor batteries are recharged via a mini USB power adaptor which plugs into the end of the wand.

All wand control shades will be made with shade fabric narrower than the ordered width on the control side, allowing the wand to hang to the side of the shade. This may cause a light gap on black-out shades.

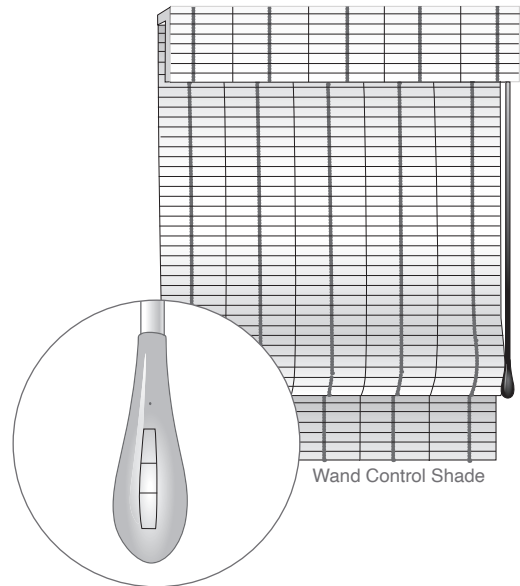

Wand Control Shade



White, Beige, Gray, Bronze, or Black Wands

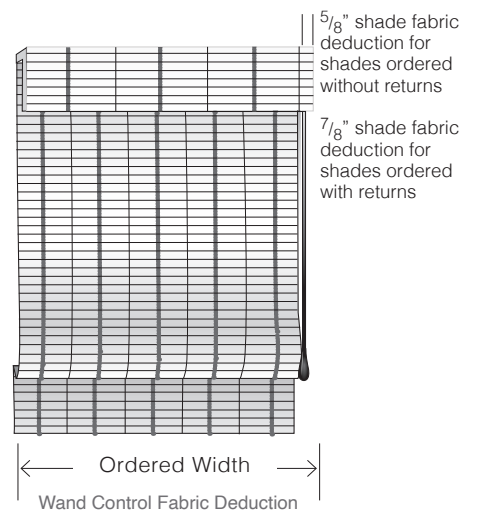

# SHADE CONTROL OPTIONS

## REMOTE CONTROL SHADES

Remote motors have rechargeable and hardwired options available which can be controlled with remotes, wall switches, or motor hubs.

See Specifications for minimum widths by motor type.



Remote  
(multi-channel)



Wall Switch  
(multi-channel)

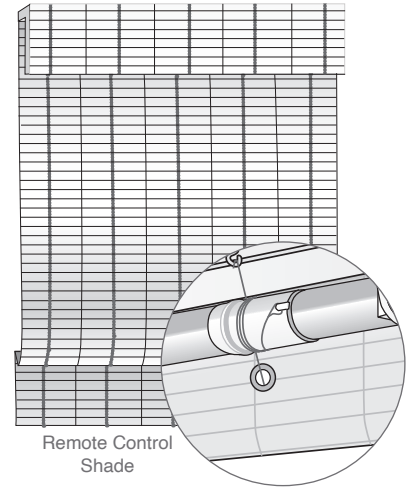

Remote Control  
Shade

Motor Tube and Spindle

## REMOTE MOTOR OPTIONS

	RECHARGEABLE LITHIUM ION	12 V DC HARDWIRED	12 V DC EXTERNAL POWER	100-240 AC HARDWIRED*
MOTOR TYPE	Standard Lift	Standard Lift	Standard Lift	Standard Lift
POWER SUPPLY	Internal	Hardwired	AA Battery Tube External LI Battery Pack	Hardwired <i>AC wall plug not available through this collection</i>
CHARGER	6'/16½' Micro-USB	-	6'/16½' Micro-USB <i>Used to recharge LI Battery Pack</i>	-
REMOTE	Single/15 Channel Remote Single/15 Channel Wall Switch	Single/15 Channel Remote Single/15 Channel Wall Switch	Single/15 Channel Remote Single/15 Channel Wall Switch	Single/15 Channel Remote Single/15 Channel Wall Switch
AUTOMATION	Pro Hub	Pro Hub	Pro Hub	Pro Hub

\*Requires installation by an electrician.

## PRO HUB

*Connects through* 2.4 GHz wifi or directly to router with ethernet cable.

*Works with* Connector+ App, Amazon Alexa, Control4, Google Home, IFTTT, RTI, Samsung Smart Things, and Siri Short Cuts.



Pro Hub

# SHADE ADDITIONAL OPTIONS

## LINED VALANCE (STANDARD SHADES)

Lined valances are included to conceal the head rail components where an open-weave pattern is selected.

All TDBU shades are made with lined valances as standard.

## BACK VALANCE/INTERIOR VALANCE (WATERFALL SHADES)

Back valances for waterfall shades are available upon request and can be ordered in either the shade fabric or the liner fabric for lined shades. Back valances conceal the shade components from the back of the shade.

Interior valances come standard with waterfall shades that are unlined or that are ordered with a light-filtering liner. Interior valances block the outline of the shade components from showing on the front of the shade. Valances are 4" long and are made with black-out White (BO01) liner material. Because the valance is made with black-out fabric, the part of the shade in front of the interior valance will look darker than the rest of the shade when light is coming through.



Waterfall Shade  
with interior and back valances



Shade with Light-Filtering  
Liner and Interior Valance

## EDGE BINDINGS

Edge binding is available for all patterns in the Walden Select Collection.

Edge binding is applied to the sides of both the shade and valance. It is not applied to the bottom of either.

Edge bindings are available in eight colors. Edge binding will show 5/8" on the face of the shade.

Some patterns are required to be ordered with edge binding, as noted in the Materials Reference table. Patterns that require edge binding have the cost of edge binding included in the base price of the shade and will have the warranty for frayed edges voided if ordered without edge binding.



Shade with Edge Binding

# SHADE ADDITIONAL OPTIONS

## CUT OUTS

Cut outs can be taken from either side of the shade. Exact dimensions and the locations of the cut outs are required.

Cut outs are not available with edge binding.

There may be limitations to what can be cut out, based upon the size and specifications of the shade. The factory will review all orders for cut outs and provide confirmation of each order within 24 hours.

## HOLD DOWN BRACKETS AND SPACER BLOCKS

Hold down brackets are supplied upon request for all control types. Clutch and motorized shades ordered with hold down brackets will be made with a round bottom bar. Cordless shades with hold down brackets will be made with a rectangular bottom bar.

Spacer blocks measuring 3/8" are available upon request. Maximum of 2 spacer blocks per bracket recommended.

## VALANCE ONLY

Valance Only is available for all fabrics. Valances can be specified in length up to 18" long and have a maximum width of 96". Valance returns will be made to the ordered length of the valance or can be requested in custom lengths.

Valances can be ordered attached to a head rail or loose. Available head rail depths for attached valances are:

1", 1½", 2½", 3 ¾", 4", or 5½".

Valances can be made with liners and edge binding for a surcharge. Please specify if valances should be lined or unlined or made with or without edge binding when placing your order.

# SHADE SPECIFICATIONS

	MINIMUM WIDTH	MAXIMUM WIDTH	MINIMUM HEIGHT	MAXIMUM HEIGHT	IB DEDUCTION (width)	FLUSH IB DEPTH (top mount w/brkt)	MINIMUM IB DEPTH (top mount w/brkt)
CORDLESS	18"	96"	18"	96"	3/8"	2 1/2"*	3/4"
CORDLESS TWIN	18"	96"	18"	96"	3/8"	4 3/8"*	3/4"
CLUTCH and LOOP	18"	96"	18"	108"	3/8"	3 1/2"*	3/4"
TOP-DOWN BOTTOM-UP (TDBU)	20"	60"	18"	84"	3/8"	2 1/2"*	3/4"
WAND CONTROL	23"	96"	18"	108"	3/8"	3 1/2"*	3/4"
Remote Control Motors							
• STANDARD LITHIUM ION	23"	96"	18"	108"	3/8"	3 1/2"*	3/4"
• STANDARD DC MOTOR	15"	96"	18"	108"	3/8"	3 1/2"*	3/4"
• STANDARD AC MOTOR	20"	96"	18"	108"	3/8"	3 1/2"*	3/4"
MULTIPLE SHADES ON ONE HR	–	108" total	–	–	–	–	–
COMMON VALANCE	–	96"	–	–	–	–	–
VALANCE ONLY	–	96"	–	18"	–	–	–

\* Flush IB depth is head rail depth plus 1" when using standard bracket. Exact measurement will vary slightly based upon fabric thickness.

# SHADE SPECIFICATIONS

## BRACKET DIMENSIONS

Height: 1½"

Depth: 1¾"

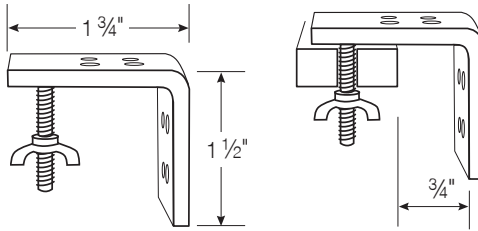

## RING SPACING

First fold starts 3½" above the bottom bar, then rings are spaced 7" apart on back of the shade.

## STACK HEIGHT

Approximately (all lengths): 8" to 10"

## HEAD RAIL DIMENSIONS

Middle support brackets will be supplied for all shades over 41" wide.

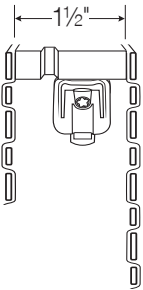

### CORDLESS HEAD RAIL

- Standard Shades
- Waterfall Shades
- TDBU

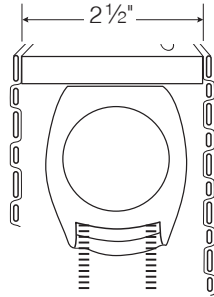

### CLUTCH SHADE with Continuous Cord Loop

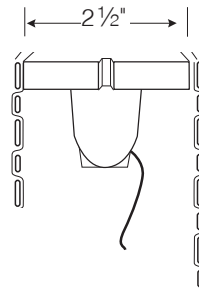

### MOTORIZED HEAD RAIL REMOTE OR WAND CONTROL

- Standard Shades
- Waterfall Shades

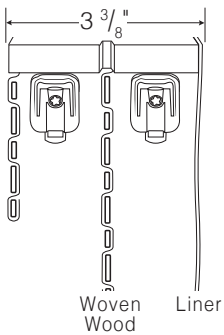

### TWIN SHADE W/CORDLESS

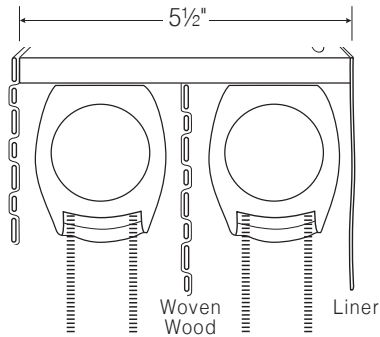

### TWIN SHADE W/2 CLUTCHES Controls Same Side (shown) or Opposite Sides

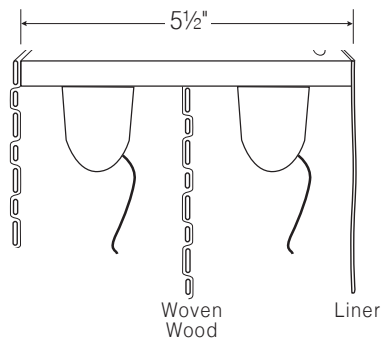

### TWIN SHADE W/2 MOTORS Controls Same Side (shown) or Opposite Sides

# FOLDING DOORS

Check the Materials Reference table for patterns which are available to be made as folding doors.

Folding doors are ideal for large windows or doors and are suspended vertically from hangers, which slide smoothly inside an aluminum track. On each side of the door are wood bars with handles. The wood bars come in six colors and either a brown or white track. Wood bar and track colors are selected to coordinate with the chosen pattern.

Folding doors come in one of two configurations: one-way opening or center opening.

## ONE-WAY OPENING

When open, the material stacks back either to the right or the left. Specify on the order form which side of the door the drapery will stack to.

**NOTE:** *If you want the material to stack back completely clear of the window, for an unobstructed view when the door is open, allow for the width of the stack in the overall width of the door. See "Specifications" for more details.*

## CENTER OPENING (SPLIT DRAW)

The door is made from two panels, which are equal width and meet in the middle. They open to opposite sides of the window.

Each panel has a wood bar on both sides and the two middle bars have small, countersunk magnets which hold the two bars together tightly when the panels are in the closed position.

## DRAPERIES STYLE

Folding doors can be ordered "drapery style," which means no edge bars. Instead, they will have edge binding on all four sides of each panel for a softer look. Wide edge binding will be used on the top, bottom, and sides of the panel.

Drapery style folding doors can also be ordered as one-way or center opening.

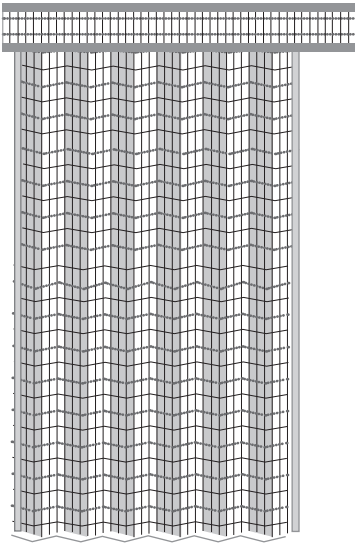

One-Way Left Stack  
shown with valance

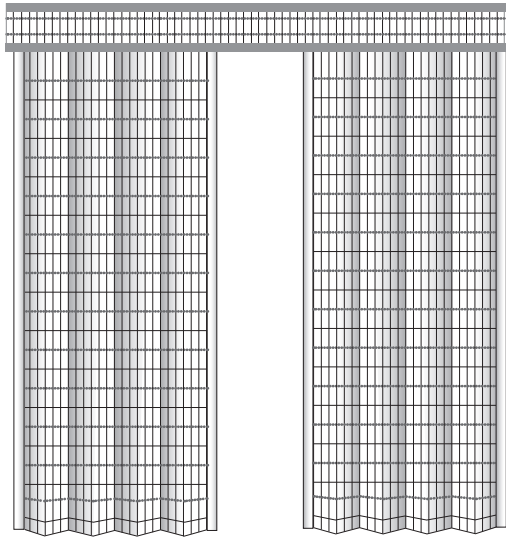

Center Opening – Split Draw  
shown with valance

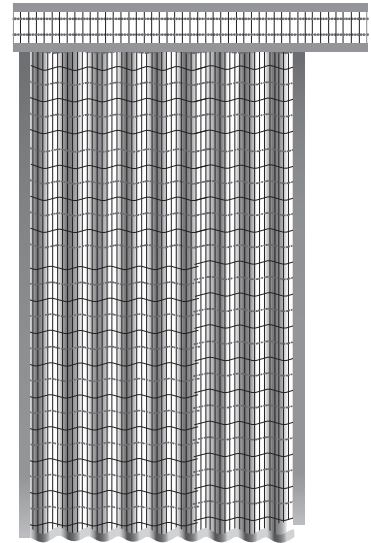

Drapery Style Left Stack  
shown with valance

# FOLDING DOOR OPTIONS

## FULLNESS

The standard folding door comes with 5% fullness, which means that it lies nearly flat when fully extended. Folding doors can be ordered with 20% fullness, which gives fuller folds; this is a surcharge option.

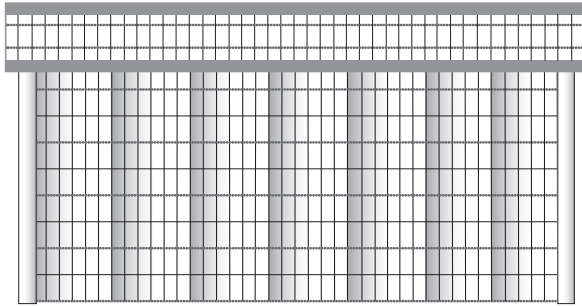

5% Fullness (fully extended)  
shown with valance

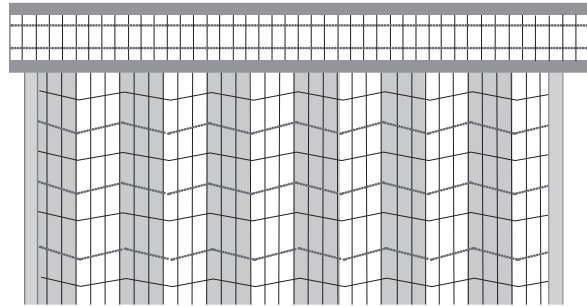

20% Fullness (fully extended)  
shown with valance

## LINERS

Linners are available in light-filtering or black-out. They are attached to the top of the folding door and are secured down both sides beneath the wood bars or edge binding.

## VALANCE

Standard folding doors come with track and panels. Adding a valance provides a decorative touch. It also conceals the track and hangers and blocks any light gap between the track and the top of the door fabric.

The valance is 8" long and is mounted to a wooden board, 5 1/2" deep and 3/4" thick. The valance is attached to the front edge of the board by velcro.

The valance is oriented in the same direction as the door (vertically) and is edge-bound on the top and bottom. Narrow edge binding is standard on folding door valances.

For inside mount shades, the valance will cover the front of the valance board only. For outside mount shades, the valance will be made to wrap around both ends of the valance board.

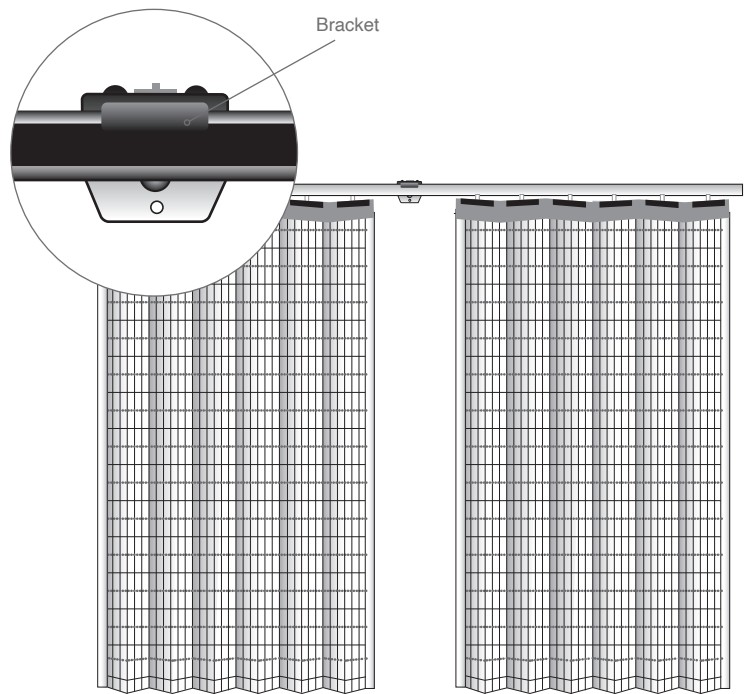

Center Opening – Split Draw  
shown without valance

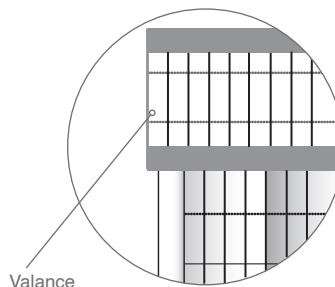

Valance



# FOLDING DOOR SPECIFICATIONS

## SIZE LIMITATIONS

Minimum Width: 24"      Minimum Height: 24"  
 Maximum Width: 192"      Maximum Height: 96"

Tracks and valance boards wider than 90" are spliced to avoid oversize freight charges.

## DOORS WITHOUT A VALANCE

For doors without a valance, the height of the folding door is measured from the top of the track to the bottom of the fabric.

There is a gap of approximately  $\frac{3}{4}$ " between the top of the track and the material. The factory will deduct this amount from the ordered length when they make the fabric panel.

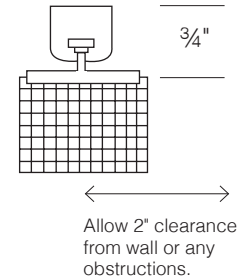

## DOORS WITH A VALANCE

For doors with a valance, the height of the folding door is measured from the top of the valance board to the bottom of the fabric.

The valance board is  $\frac{3}{4}$ " thick and there is  $\frac{3}{4}$ " between the top of the track and the top of the material. The factory will deduct  $1\frac{1}{2}$ " from the ordered length when they make the fabric panel.

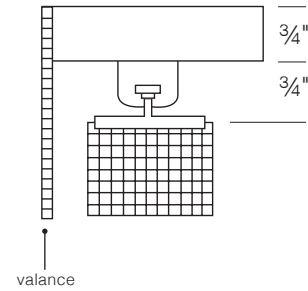

## INSIDE MOUNT MEASUREMENTS

Minimum Inside Mount Depth: 2"

Check for any obstructions, such as trim or handles that may interfere with the opening and closing of the door.

Inside Mount Deductions:

Width:  $\frac{1}{4}$ "  
 Height:  $\frac{3}{4}$ "

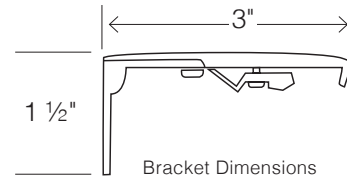

No deductions are made to the width or height of outside mount doors.

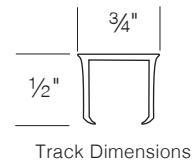

## STACKING CHART (5% FULLNESS)

WIDTH	STACK
36"	8 $\frac{1}{2}$ "
42"	9"
48"	9 $\frac{1}{2}$ "
60"	11"
72"	12"
84"	13"
96"	14"

Center opening (or split draw) folding doors will open into two equal stacks on each side. For example a 96" center opening will have two stacks, each the size of a 48" one-way opening door: 9 $\frac{1}{2}$ ".

20% fullness folding doors will stack approximately 1" wider for small doors and 1 $\frac{1}{2}$ " wider for larger doors than same size at 5% fullness.

All stacking dimensions are approximate and will vary by pattern.

# SLIDING PANELS

## CONSTRUCTION AND OPERATION

- Sliding panels provide a clean, contemporary look for large windows and doors.
- Overlapping panels are suspended from hangers, which glide smoothly on an aluminum track and pass in front or behind each other, allowing panels to stack away from the window.
- Panels are attached to the track and are supplied with narrow edge binding to protect them from wear and tear and are custom sized, based on the ordered width and the number of panels.
- Sliding panels are operated with 48" wands; a center-opening sliding panel will have two wands.
- All patterns are able to be made as Sliding Panels.

**NOTE:** Because bamboo and natural materials can stretch or shrink, we recommend that panels are ordered with at least  $\frac{3}{4}$ " clearance from the ground. When shipped from the factory, panels may be slightly different lengths (up to  $\frac{1}{2}$ " from the ordered length). A shorter panel can be corrected by gently pulling on the bottom of the panel until it is the same length as longer panels.



Wand Colors

## ONE-WAY OPENING

- When open, all of panels stack back to either the right or the left. *Specify on the order to which side of the window the panels will stack.*
- The standard configuration is for the back panel to be stationary and all the other panels stack in front.
- Reverse stacking is available, with the front panel stationary. Free-floating panels are also available.
- **NOTE:** *If you want the panels to stack completely away from the window for an unobstructed view, allow for the panel width in the overall width of the shade. See "Specifications" for more details.*



One-Way Left Stacked

## CENTER OPENING (SPLIT DRAW)

- Must be made with an even number of panels. Panels stack to both sides.
- When made with four panels, the front left and back right panels are stationary.
- If made with six or eight panels, the back panels on both sides will be stationary and all other panels will stack in front on both sides. See Sliding Panel Configurations on page 21.
- Reverse stacking and free-floating panels are also available.



Center Opening

# SLIDING PANEL SPECIFICATIONS

## LINERS

- Available in light-filtering or black-out.
- Sewn under the edge binding on all four panel sides.

## EDGE BINDING

- Panels will come with narrow (1") edge binding as standard, which means that 1/2" is visible on the face of the panels.

## VALANCE

- Valances are 8" long and attached to the front and sides of the track by velcro. If a valance is part of the original sliding panel order, the velcro for the valance will be riveted to the front of the track to ensure a lasting bond.
- Valances are cut up the roll, so they wrap around the ends of the track. This means the valance material is railroaded and will be oriented differently to the panels. For inside mount sliding panels, the valance will cover the front of the track only. For outside mount sliding panels the valance will be made to wrap around both ends of the track.
- When ordered separately, both velcro halves are provided, but the bond between the velcro and the track will not be as durable.

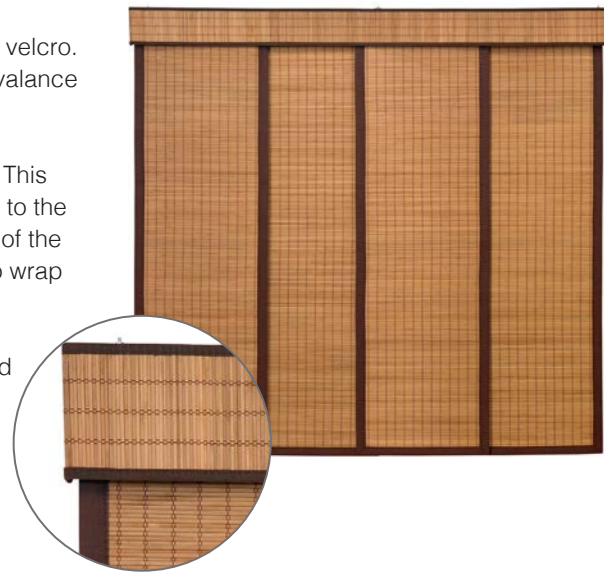

# SLIDING PANEL SPECIFICATIONS

## SIZE LIMITATIONS

Minimum Width: 48"      Minimum Height: 24"  
 Maximum Width: 144"      Maximum Height: 120"

Tracks wider than 90" are spliced to avoid oversize freight charges.

## STANDARD PANEL CONFIGURATIONS

WIDTH	TYPE OF OPENING	# OF PANELS	TRACK TYPE
48" – 84"	One-Way	3 Panels	3 Channel
	Center Opening	4 Panels	2 Channel
84 1/4" – 120"	One-Way	4 Panels	4 Channel
	Center Opening	4 Panels	2 Channel
120 1/4" – 144"	One-Way	5 Panels	5 Channel
	Center Opening	6 Panels	4 Channel

## TYPICAL PANEL SIZES (OUTSIDE MOUNT SHADE)

WIDTH	ONE-WAY DRAW		CENTER OPENING	
60"	3 panels	21 5/8"	4 panels	16 7/8"
72"	3 panels	25 5/8"	4 panels	19 7/8"
84"	3 panels	29 5/8"	4 panels	22 7/8"
96"	4 panels	25 7/8"	4 panels	25 7/8"
108"	4 panels	28 7/8"	4 panels	28 7/8"
120"	4 panels	31 7/8"	4 panels	31 7/8"
132"	5 panels	28 3/8"	6 panels	24 1/8"
144"	5 panels	30 3/4"	6 panels	26 1/4"

## PANEL SIZE CALCULATIONS

To calculate the approximate panel width, use the ordered width and the number of panels.

Deduct one from the number of panels and multiply this number by 2.5. Then add this number to the ordered width and divide the resulting number by the number of panels.

**For example:** For a sliding panel order with an 80" width and 5 panels, each panel will be approximately 18" wide.

$$5 \text{ (panels)} - 1 = 4$$

$$4 \times 2.5" = 10"$$

$$80" \text{ (ordered width)} + 10" = 90"$$

$$90" / 5 \text{ (panels)} = 18" \text{ panel width}$$

## TRACK DIMENSIONS

TRACK DEPTHS	
3 Channel	2"
4 Channel	2 3/4"
5 Channel	3 3/8"

The distance from the top of the track to the top of the panels is 1". The factory will take account of this distance when calculating the panel length.

## MOUNTING DEPTHS

	3 TRACK	4 TRACK	5 TRACK
Minimum IB	2"	2 3/4"	3 3/8"
Flush IB	2 1/2"	3 1/4"	3 7/8"

Wall or Face Mount: 1/4" flat mounting surface required.  
(Using L Bracket)

## INSIDE MOUNT DEDUCTIONS

IB Deduction (Width): 1/4"  
 IB Deduction (Height): 1/2"

## DISTANCE FROM THE WALL TO THE BACK OF THE TRACK (CLEARANCE)

	3-CHANNEL TRACK	4-CHANNEL TRACK	5-CHANNEL TRACK
Standard Bracket (2 7/8")	1 3/8"	1 1/4"	3/4"
Large Bracket (4 1/4")	2 1/2"	2 3/8"	1 7/8"

Adding an extension bracket will provide an extra 2 7/8" of clearance from the wall.

Add the track depth to the clearance to calculate the total projection into the room.

## SLIDING PANEL BRACKET

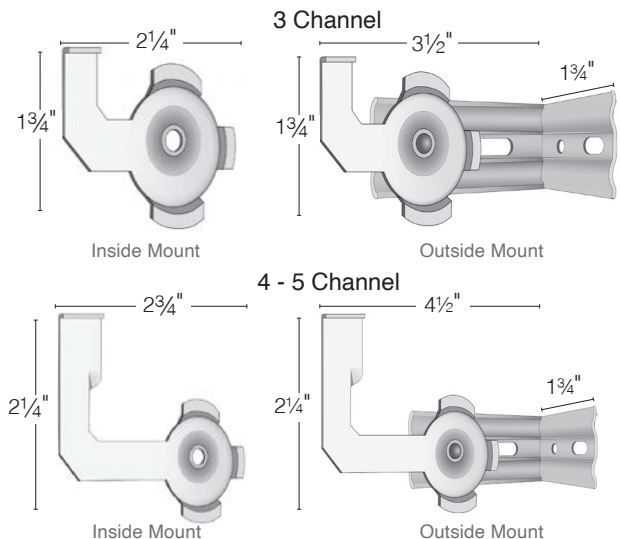

# SLIDING PANEL CONFIGURATIONS

## GENERAL OPERATION

Open

Closed

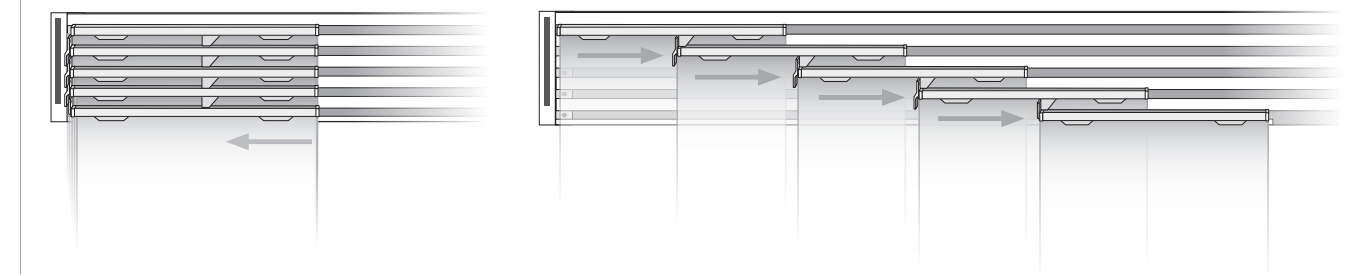

## ONE WAY CONFIGURATIONS

3 Channel Track / 3 Panels / One Way Left

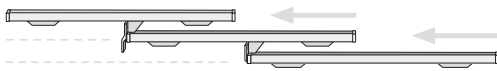

3 Channel Track / 3 Panels / One Way Right

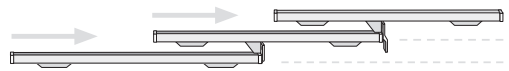

4 Channel Track / 4 Panels / One Way Left

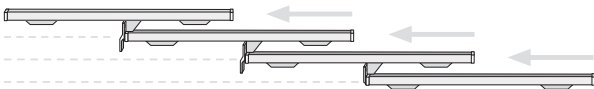

4 Channel Track / 4 Panels / One Way Right

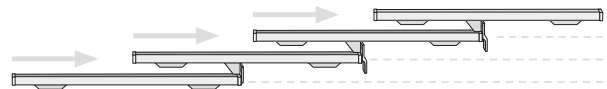

5 Channel Track / 5 Panels / One Way Left

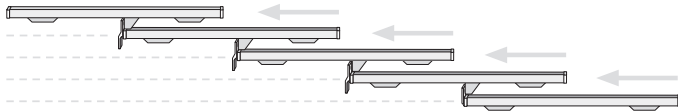

5 Channel Track / 5 Panels / One Way Right

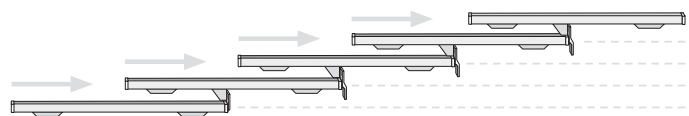

## CENTER SPLIT CONFIGURATIONS

2 Channel Track / 4 Panels / Center Split  
*stationary front left and back right*

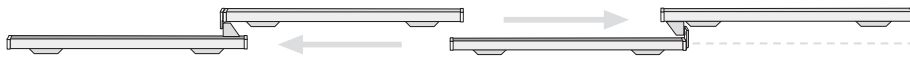

4 Channel Track / 6 Panels / Center Split

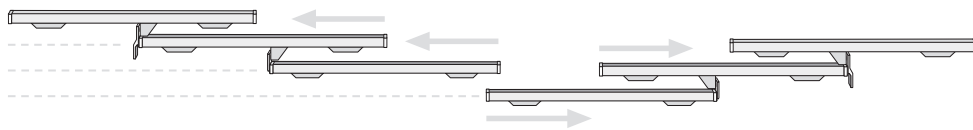

5 Channel Track / 8 Panels / Center Split

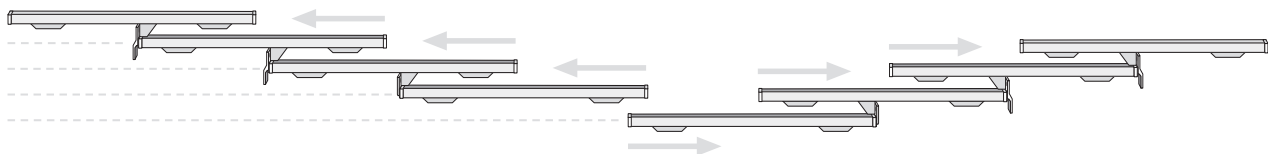

# SHADE PRICING | GROUP A – C

Pricing includes Cordless and Clutch shades.

## WIDTH

PRICE GROUP A Pudong	LENGTH	24"	30"	36"	42"	48"	60"	72"	84"	96"
		36"	\$278	\$284	\$321	\$345	\$371	\$465	\$506	\$587
48"	\$302	\$331	\$358	\$391	\$420	\$530	\$576	\$672	\$724	
54"	\$315	\$358	\$378	\$410	\$449	\$563	\$620	\$712	\$774	
60"	\$327	\$368	\$400	\$431	\$463	\$590	\$666	\$752	\$824	
66"	\$338	\$378	\$420	\$453	\$490	\$653	\$705	\$813	\$893	
72"	\$350	\$394	\$440	\$476	\$513	\$676	\$735	\$874	\$960	
78"	\$366	\$413	\$460	\$505	\$549	\$709	\$784	\$916	\$1,010	
84"	\$380	\$431	\$482	\$530	\$586	\$742	\$818	\$960	\$1,071	
96"	\$406	\$464	\$523	\$578	\$632	\$825	\$924	\$1,076	\$1,203	
108"	\$443	\$509	\$575	\$637	\$697	\$910	\$1,020	\$1,190	\$1,332	
<b>VALANCE ONLY</b>	18"	\$138	\$142	\$172	\$192	\$213	\$260	\$292	\$340	\$373

## WIDTH

PRICE GROUP B Cala Malvern Osaka	LENGTH	24"	30"	36"	42"	48"	60"	72"	84"	96"
		36"	\$314	\$335	\$374	\$397	\$420	\$506	\$556	\$651
48"	\$357	\$394	\$431	\$463	\$495	\$582	\$638	\$752	\$851	
54"	\$367	\$410	\$452	\$487	\$522	\$617	\$679	\$803	\$901	
60"	\$380	\$426	\$472	\$510	\$548	\$653	\$721	\$851	\$952	
66"	\$394	\$444	\$493	\$535	\$576	\$688	\$764	\$897	\$1,000	
72"	\$409	\$462	\$515	\$559	\$604	\$721	\$807	\$943	\$1,048	
78"	\$421	\$479	\$536	\$585	\$632	\$757	\$848	\$987	\$1,099	
84"	\$434	\$496	\$556	\$608	\$659	\$792	\$890	\$1,032	\$1,150	
96"	\$464	\$551	\$598	\$657	\$714	\$893	\$1,010	\$1,165	\$1,293	
108"	\$509	\$585	\$658	\$724	\$789	\$986	\$1,118	\$1,290	\$1,432	
<b>VALANCE ONLY</b>	18"	\$166	\$183	\$215	\$233	\$251	\$292	\$333	\$390	\$443

## WIDTH

PRICE GROUP C Lou Metro Terra Umbria	LENGTH	24"	30"	36"	42"	48"	60"	72"	84"	96"
		36"	\$347	\$378	\$413	\$433	\$472	\$593	\$669	\$808
48"	\$373	\$416	\$459	\$486	\$513	\$665	\$752	\$904	\$1,039	
54"	\$390	\$437	\$485	\$516	\$546	\$695	\$811	\$970	\$1,088	
60"	\$409	\$459	\$507	\$543	\$586	\$744	\$848	\$1,010	\$1,158	
66"	\$427	\$479	\$530	\$568	\$621	\$792	\$909	\$1,079	\$1,228	
72"	\$443	\$499	\$553	\$594	\$649	\$850	\$975	\$1,157	\$1,314	
78"	\$462	\$520	\$579	\$631	\$697	\$891	\$1,022	\$1,214	\$1,383	
84"	\$477	\$540	\$604	\$668	\$731	\$932	\$1,071	\$1,270	\$1,451	
96"	\$510	\$582	\$651	\$721	\$803	\$1,039	\$1,210	\$1,419	\$1,610	
108"	\$562	\$642	\$718	\$799	\$890	\$1,152	\$1,343	\$1,575	\$1,790	
<b>VALANCE ONLY</b>	18"	\$193	\$218	\$246	\$261	\$292	\$363	\$423	\$516	\$595

# SHADE PRICING | GROUPS D – F

Pricing includes Cordless and Clutch shades.

## WIDTH

PRICE GROUP D Antilles Camden Chelsea Halifax Harbor Montana Nantucket Parchment Portland Sonoma Tortola	LENGTH	24"	30"	36"	42"	48"	60"	72"	84"	96"
		36"	\$386	\$400	\$437	\$460	\$482	\$617	\$698	\$840
48"	\$397	\$436	\$489	\$519	\$549	\$702	\$800	\$957	\$1,092	
54"	\$416	\$472	\$528	\$555	\$582	\$742	\$850	\$1,015	\$1,160	
60"	\$433	\$500	\$552	\$589	\$614	\$782	\$900	\$1,074	\$1,226	
66"	\$452	\$516	\$579	\$612	\$647	\$874	\$985	\$1,158	\$1,322	
72"	\$472	\$530	\$591	\$637	\$681	\$911	\$1,048	\$1,243	\$1,415	
78"	\$486	\$552	\$616	\$712	\$731	\$954	\$1,099	\$1,304	\$1,486	
84"	\$507	\$575	\$642	\$746	\$781	\$999	\$1,151	\$1,362	\$1,560	
96"	\$546	\$622	\$697	\$754	\$849	\$1,134	\$1,309	\$1,551	\$1,769	
108"	\$601	\$687	\$771	\$836	\$941	\$1,257	\$1,455	\$1,725	\$1,970	
<b>VALANCE ONLY</b>	18"	\$224	\$235	\$265	\$283	\$301	\$383	\$446	\$541	\$639

## WIDTH

PRICE GROUP E Alisia Andros Como Fay Peri Selene	LENGTH	24"	30"	36"	42"	48"	60"	72"	84"	96"
		36"	\$452	\$469	\$513	\$539	\$566	\$716	\$808	\$966
48"	\$473	\$517	\$578	\$612	\$648	\$817	\$928	\$1,104	\$1,256	
54"	\$497	\$560	\$624	\$656	\$688	\$865	\$988	\$1,171	\$1,334	
60"	\$520	\$596	\$655	\$698	\$727	\$914	\$1,047	\$1,240	\$1,411	
66"	\$545	\$617	\$689	\$727	\$768	\$1,019	\$1,144	\$1,337	\$1,521	
72"	\$571	\$637	\$706	\$758	\$810	\$1,064	\$1,218	\$1,434	\$1,627	
78"	\$591	\$665	\$739	\$845	\$869	\$1,115	\$1,279	\$1,506	\$1,710	
84"	\$619	\$694	\$771	\$888	\$928	\$1,168	\$1,339	\$1,573	\$1,795	
96"	\$669	\$756	\$839	\$905	\$1,010	\$1,325	\$1,521	\$1,790	\$2,033	
108"	\$738	\$835	\$929	\$1,003	\$1,120	\$1,468	\$1,690	\$1,989	\$2,264	
<b>VALANCE ONLY</b>	18"	\$277	\$290	\$325	\$347	\$368	\$461	\$535	\$643	\$753

## WIDTH

PRICE GROUP F Soft Jute	LENGTH	24"	30"	36"	42"	48"	60"	72"	84"	96"
		36"	\$506	\$554	\$609	\$640	\$701	\$870	\$988	\$1,190
48"	\$552	\$618	\$686	\$728	\$771	\$986	\$1,121	\$1,342	\$1,548	
54"	\$582	\$655	\$728	\$777	\$825	\$1,035	\$1,214	\$1,445	\$1,625	
60"	\$614	\$691	\$767	\$822	\$889	\$1,112	\$1,274	\$1,509	\$1,735	
66"	\$647	\$725	\$805	\$863	\$945	\$1,190	\$1,368	\$1,617	\$1,844	
72"	\$674	\$760	\$844	\$906	\$992	\$1,280	\$1,471	\$1,737	\$1,978	
78"	\$706	\$796	\$887	\$966	\$1,067	\$1,346	\$1,546	\$1,827	\$2,085	
84"	\$734	\$830	\$927	\$1,027	\$1,123	\$1,411	\$1,623	\$1,915	\$2,190	
96"	\$792	\$902	\$1,007	\$1,115	\$1,239	\$1,580	\$1,840	\$2,147	\$2,437	
108"	\$877	\$1,001	\$1,116	\$1,239	\$1,378	\$1,758	\$2,048	\$2,389	\$2,718	
<b>VALANCE ONLY</b>	18"	\$320	\$359	\$402	\$427	\$476	\$584	\$679	\$821	\$943

# SHADE SURCHARGE OPTION PRICING

Add any applicable surcharges below to the retail price of the basic shade.

## WIDTH

LIGHT-FILTERING LINERS <i>Light-filtering liners are the same color on both sides.</i>	LENGTH	24"	30"	36"	42"	48"	60"	72"	84"	96"
		36"	\$34	\$44	\$52	\$60	\$70	\$86	\$104	\$122
Beige Black Gray Soft White	48"	\$45	\$56	\$67	\$78	\$89	\$112	\$134	\$156	\$179
	54"	\$49	\$61	\$74	\$86	\$100	\$124	\$149	\$173	\$198
	60"	\$55	\$68	\$82	\$96	\$109	\$137	\$164	\$191	\$218
	66"	\$60	\$74	\$89	\$104	\$119	\$149	\$179	\$208	\$238
	72"	\$64	\$81	\$97	\$113	\$128	\$161	\$193	\$225	\$258
	78"	\$70	\$86	\$104	\$122	\$139	\$173	\$208	\$243	\$277
	84"	\$74	\$93	\$112	\$130	\$149	\$186	\$223	\$259	\$298
	96"	\$85	\$105	\$127	\$147	\$168	\$210	\$253	\$295	\$337
	108"	\$94	\$117	\$141	\$165	\$188	\$235	\$283	\$329	\$377

## WIDTH

BLACK-OUT LINERS <i>Black-out liners are off white to the street.</i>	LENGTH	24"	30"	36"	42"	48"	60"	72"	84"	96"
		36"	\$37	\$45	\$55	\$64	\$72	\$91	\$109	\$127
Beige White Espresso	48"	\$46	\$59	\$70	\$82	\$94	\$117	\$141	\$164	\$187
	54"	\$52	\$66	\$78	\$91	\$104	\$130	\$156	\$182	\$209
	60"	\$57	\$71	\$86	\$100	\$115	\$143	\$172	\$201	\$229
	66"	\$63	\$78	\$94	\$109	\$126	\$156	\$187	\$218	\$250
	72"	\$68	\$85	\$101	\$119	\$135	\$169	\$203	\$238	\$270
	78"	\$72	\$91	\$109	\$127	\$146	\$182	\$218	\$255	\$292
	84"	\$78	\$98	\$117	\$137	\$156	\$195	\$235	\$273	\$313
	96"	\$89	\$111	\$132	\$154	\$178	\$221	\$266	\$310	\$354
	108"	\$98	\$124	\$149	\$173	\$198	\$247	\$296	\$347	\$396

## WIDTH

EDGE BINDING*	LENGTH	24"	30"	36"	42"	48"	60"	72"	84"	96"
		36"	\$38	\$40	\$42	\$44	\$46	\$51	\$55	\$59
Camel Navy Olive Onyx Pearl Stone Titanium Wheat	48"	\$46	\$48	\$51	\$52	\$55	\$59	\$63	\$67	\$71
	54"	\$51	\$52	\$55	\$56	\$59	\$63	\$67	\$71	\$75
	60"	\$55	\$56	\$59	\$60	\$63	\$67	\$71	\$75	\$79
	66"	\$59	\$60	\$63	\$64	\$67	\$71	\$75	\$79	\$83
	72"	\$63	\$64	\$67	\$68	\$71	\$75	\$79	\$83	\$87
	78"	\$67	\$68	\$71	\$72	\$75	\$79	\$83	\$87	\$91
	84"	\$71	\$72	\$75	\$78	\$79	\$83	\$87	\$91	\$96
	96"	\$79	\$82	\$83	\$86	\$87	\$91	\$96	\$100	\$104
	108"	\$87	\$90	\$91	\$94	\$96	\$100	\$104	\$108	\$113

\*Edge Binding Surcharge does not apply for fabrics that require edge binding.

VALANCE ONLY LINER SURCHARGE: \$38

VALANCE ONLY EDGE BINDING SURCHARGE\*: \$23

\*Edge Binding Surcharge does not apply for fabrics that require edge binding.



# SHADE SURCHARGE OPTION PRICING

## STYLE OPTIONS

### MULTIPLE SHADES ON ONE HEAD RAIL

Add surcharge to price of two/three individual shades:

2-ON-1: **\$52** surcharge

3-ON-1: **\$65** surcharge

**TWIN SHADE (MOVABLE LINER): \$309** surcharge

Add surcharge to cost of shade with liner.

**TDBU: \$140**

**FABRIC VALANCE RETURNS: \$39**

Made of edge binding material.

**STAINLESS STEEL CHAIN: \$37**

**CUT OUTS: \$39** each cut out

## WAND CONTROL SHADES

**WAND CONTROL MOTOR: \$235** (includes Wand)

### WAND CONTROL BATTERY CHARGER

Chargers are not included with motorized shades; please identify desired quantity when placing order.

**USB WAND CHARGER: \$65**



White, Beige, Gray, Bronze, or Black Wands

## REMOTE CONTROL SHADES

Chargers are not included with motorized shades; please identify desired quantity when placing order.

**REMOTE CONTROL MOTOR (LI, DC, AC STYLES): \$350**

### REMOTES

**SINGLE-CHANNEL REMOTE: \$71**

**MULTI-CHANNEL REMOTE: \$90**



Single-Channel Remote



Multi-Channel Remote

### WALL SWITCHES

**SINGLE-CHANNEL SWITCH: \$126**

**MULTI-CHANNEL SWITCH: \$161**



Single-Channel Switch



Multi-Channel Switch

**PRO HUB: \$468**



Pro Hub

## REMOTE CONTROL CHARGERS AND BATTERIES

Chargers are not included with motorized shades; please identify desired quantity when placing order.

**USB REMOTE MOTOR CHARGER (6' CABLE): \$65**

**USB REMOTE MOTOR CHARGER (16½' CABLE): \$81**

**RECHARGEABLE LITHIUM ION BATTERY PACK (POWERS DC MOTOR): \$120**

# FOLDING DOOR PRICING – ONE WAY OPENING

All tracks and valance boards over 90" wide will be spliced to avoid oversize freight charges.

## 5% FULLNESS

### WIDTH

PRICE GROUP A Pudong	LENGTH	48"	60"	72"	84"	96"	120"	132"	144"	156"	168"	180"	192"
		48"	\$382	\$450	\$515	\$596	\$675	\$826	\$902	\$978	\$1,054	\$1,130	\$1,206
	60"	\$426	\$504	\$579	\$669	\$758	\$929	\$1,015	\$1,101	\$1,187	\$1,273	\$1,359	\$1,444
	72"	\$470	\$557	\$642	\$742	\$841	\$1,033	\$1,129	\$1,224	\$1,320	\$1,415	\$1,511	\$1,606
	84"	\$514	\$611	\$706	\$815	\$923	\$1,137	\$1,244	\$1,350	\$1,457	\$1,564	\$1,671	\$1,778
	96"	\$558	\$665	\$769	\$888	\$1,006	\$1,240	\$1,359	\$1,477	\$1,595	\$1,713	\$1,831	\$1,950
VALANCE		\$114	\$118	\$150	\$153	\$190	\$236	\$253	\$269	\$285	\$301	\$317	\$334

### WIDTH

PRICE GROUP B Cala Malvern Osaka	LENGTH	48"	60"	72"	84"	96"	120"	132"	144"	156"	168"	180"	192"
		48"	\$406	\$480	\$552	\$638	\$723	\$887	\$968	\$1,048	\$1,129	\$1,210	\$1,291
	60"	\$456	\$542	\$624	\$722	\$818	\$1,005	\$1,099	\$1,193	\$1,287	\$1,381	\$1,475	\$1,569
	72"	\$507	\$603	\$697	\$806	\$913	\$1,124	\$1,229	\$1,335	\$1,440	\$1,545	\$1,651	\$1,756
	84"	\$557	\$665	\$769	\$890	\$1,008	\$1,243	\$1,360	\$1,476	\$1,593	\$1,709	\$1,826	\$1,943
	96"	\$607	\$726	\$842	\$973	\$1,104	\$1,362	\$1,491	\$1,621	\$1,750	\$1,880	\$2,010	\$2,139
VALANCE		\$127	\$132	\$167	\$172	\$214	\$267	\$287	\$306	\$326	\$345	\$364	\$384

### WIDTH

PRICE GROUP C Lou Metro Umbria	LENGTH	48"	60"	72"	84"	96"	120"	132"	144"	156"	168"	180"	192"
		48"	\$448	\$532	\$614	\$711	\$807	\$991	\$1,080	\$1,169	\$1,258	\$1,347	\$1,436
	60"	\$508	\$607	\$702	\$813	\$923	\$1,136	\$1,241	\$1,346	\$1,452	\$1,557	\$1,662	\$1,767
	72"	\$569	\$681	\$791	\$915	\$1,039	\$1,281	\$1,402	\$1,524	\$1,645	\$1,766	\$1,888	\$2,009
	84"	\$630	\$756	\$879	\$1,017	\$1,154	\$1,425	\$1,560	\$1,694	\$1,829	\$1,963	\$2,098	\$2,232
	96"	\$690	\$830	\$967	\$1,119	\$1,270	\$1,570	\$1,721	\$1,872	\$2,022	\$2,173	\$2,323	\$2,474
VALANCE		\$147	\$156	\$194	\$203	\$252	\$298	\$321	\$343	\$366	\$389	\$411	\$434

# FOLDING DOOR SURCHARGE PRICING

All tracks and valance boards over 90" wide will be spliced to avoid oversize freight charges.

## 5% FULLNESS

### WIDTH

PRICE GROUP D Chelsea	LENGTH	WIDTH											
		48"	60"	72"	84"	96"	120"	132"	144"	156"	168"	180"	192"
	48"	\$530	\$631	\$727	\$842	\$955	\$1,173	\$1,279	\$1,384	\$1,490	\$1,595	\$1,701	\$1,806
	60"	\$602	\$719	\$832	\$963	\$1,093	\$1,345	\$1,470	\$1,594	\$1,719	\$1,844	\$1,969	\$2,093
	72"	\$674	\$807	\$936	\$1,084	\$1,230	\$1,517	\$1,661	\$1,804	\$1,948	\$2,092	\$2,236	\$2,380
	84"	\$746	\$895	\$1,041	\$1,205	\$1,367	\$1,688	\$1,847	\$2,007	\$2,166	\$2,325	\$2,484	\$2,644
	96"	\$818	\$983	\$1,145	\$1,326	\$1,505	\$1,860	\$2,038	\$2,217	\$2,395	\$2,573	\$2,752	\$2,930
VALANCE		\$174	\$184	\$230	\$240	\$298	\$353	\$380	\$407	\$434	\$460	\$487	\$514

### WIDTH

PRICE GROUP E Alisia Andros Fay	LENGTH	WIDTH											
		48"	60"	72"	84"	96"	120"	132"	144"	156"	168"	180"	192"
	48"	\$634	\$754	\$870	\$1,007	\$1,143	\$1,403	\$1,530	\$1,656	\$1,782	\$1,908	\$2,034	\$2,161
	60"	\$720	\$860	\$995	\$1,152	\$1,307	\$1,609	\$1,758	\$1,907	\$2,056	\$2,205	\$2,354	\$2,503
	72"	\$806	\$965	\$1,120	\$1,296	\$1,471	\$1,814	\$1,986	\$2,158	\$2,330	\$2,502	\$2,674	\$2,846
	84"	\$892	\$1,071	\$1,245	\$1,441	\$1,635	\$2,019	\$2,210	\$2,400	\$2,590	\$2,781	\$2,971	\$3,162
	96"	\$978	\$1,176	\$1,370	\$1,586	\$1,799	\$2,224	\$2,438	\$2,651	\$2,864	\$3,078	\$3,291	\$3,505
VALANCE		\$208	\$221	\$275	\$287	\$357	\$422	\$454	\$486	\$518	\$551	\$583	\$615

### WIDTH

LIGHT-FILTERING LINERS <i>Light-filtering liners are the same color on both sides.</i> Beige Black Gray Soft White	LENGTH	WIDTH											
		48"	60"	72"	84"	96"	120"	132"	144"	156"	168"	180"	192"
	48"	\$122	\$144	\$165	\$191	\$217	\$266	\$290	\$315	\$339	\$363	\$387	\$412
	60"	\$137	\$163	\$187	\$217	\$246	\$302	\$330	\$358	\$386	\$414	\$442	\$471
	72"	\$152	\$181	\$209	\$242	\$274	\$337	\$369	\$400	\$432	\$464	\$495	\$527
	84"	\$167	\$199	\$231	\$267	\$303	\$373	\$408	\$443	\$478	\$513	\$548	\$583
	96"	\$182	\$218	\$253	\$292	\$331	\$409	\$447	\$486	\$525	\$564	\$603	\$642
VALANCE*		\$38	\$40	\$50	\$52	\$64	\$80	\$86	\$92	\$98	\$103	\$109	\$115

\*If folding door is ordered with a liner, there will be no additional lined valance surcharge.

### WIDTH

BLACK-OUT LINERS <i>Black-out liners are off white to the street.</i> Beige Espresso White	LENGTH	WIDTH											
		48"	60"	72"	84"	96"	120"	132"	144"	156"	168"	180"	192"
	48"	\$162	\$192	\$221	\$255	\$289	\$355	\$387	\$419	\$452	\$484	\$517	\$549
	60"	\$183	\$217	\$250	\$289	\$327	\$402	\$440	\$477	\$515	\$552	\$590	\$628
	72"	\$203	\$241	\$279	\$322	\$365	\$450	\$492	\$534	\$576	\$618	\$660	\$702
	84"	\$223	\$266	\$308	\$356	\$403	\$497	\$544	\$590	\$637	\$684	\$730	\$777
	96"	\$243	\$290	\$337	\$389	\$441	\$545	\$597	\$648	\$700	\$752	\$804	\$856
VALANCE*		\$51	\$53	\$67	\$69	\$85	\$107	\$115	\$122	\$130	\$138	\$146	\$154

\*If folding door is ordered with a liner, there will be no additional lined valance surcharge.

20% FULLNESS: ADD 20%  
SPLIT DRAW (CENTER-OPENING): \$157

NET FREIGHT SURCHARGE:  
UP TO 93" LONG: \$40  
OVER 93" LONG: \$100

# SLIDING PANEL PRICING – PRICE GROUPS A-C

All tracks and valance boards over 90" wide will be spliced to avoid oversize freight charges.

## WIDTH

PRICE GROUP A Pudong	LENGTH	WIDTH											
		60"	72"	84"	96"	108"	120"	132"	144"	156"	168"	180"	192"
	60"	\$659	\$742	\$831	\$941	\$1,024	\$1,113	\$1,202	\$1,279	\$1,386	\$1,493	\$1,599	\$1,706
	72"	\$713	\$804	\$902	\$1,025	\$1,116	\$1,214	\$1,314	\$1,400	\$1,517	\$1,634	\$1,751	\$1,867
	84"	\$767	\$867	\$974	\$1,108	\$1,208	\$1,315	\$1,427	\$1,521	\$1,648	\$1,775	\$1,902	\$2,029
	96"	\$822	\$930	\$1,045	\$1,192	\$1,300	\$1,415	\$1,539	\$1,642	\$1,779	\$1,916	\$2,053	\$2,190
	108"	\$925	\$1,046	\$1,176	\$1,341	\$1,463	\$1,592	\$1,732	\$1,848	\$2,002	\$2,156	\$2,310	\$2,464
	120"	\$1,027	\$1,163	\$1,306	\$1,490	\$1,625	\$1,769	\$1,924	\$2,053	\$2,224	\$2,395	\$2,566	\$2,737
VALANCE		\$48	\$57	\$66	\$75	\$85	\$94	\$103	\$113	\$123	\$132	\$142	\$151

## WIDTH

PRICE GROUP B Cala Malvern Osaka	LENGTH	WIDTH											
		60"	72"	84"	96"	108"	120"	132"	144"	156"	168"	180"	192"
	60"	\$673	\$759	\$851	\$964	\$1,049	\$1,141	\$1,232	\$1,313	\$1,422	\$1,532	\$1,641	\$1,750
	72"	\$731	\$825	\$926	\$1,052	\$1,147	\$1,248	\$1,351	\$1,441	\$1,561	\$1,681	\$1,801	\$1,921
	84"	\$788	\$891	\$1,001	\$1,140	\$1,244	\$1,354	\$1,470	\$1,568	\$1,699	\$1,830	\$1,960	\$2,091
	96"	\$845	\$958	\$1,077	\$1,229	\$1,341	\$1,460	\$1,588	\$1,696	\$1,837	\$1,978	\$2,120	\$2,261
	108"	\$951	\$1,077	\$1,211	\$1,382	\$1,509	\$1,643	\$1,787	\$1,908	\$2,067	\$2,226	\$2,385	\$2,544
	120"	\$1,057	\$1,197	\$1,346	\$1,536	\$1,677	\$1,825	\$1,985	\$2,120	\$2,296	\$2,473	\$2,650	\$2,826
VALANCE		\$49	\$59	\$70	\$79	\$89	\$99	\$108	\$119	\$128	\$138	\$148	\$158

## WIDTH

PRICE GROUP C Lou Metro Terra Umbria	LENGTH	WIDTH											
		60"	72"	84"	96"	108"	120"	132"	144"	156"	168"	180"	192"
	60"	\$686	\$774	\$869	\$984	\$1,072	\$1,166	\$1,260	\$1,343	\$1,454	\$1,566	\$1,678	\$1,790
	72"	\$746	\$844	\$947	\$1,077	\$1,174	\$1,278	\$1,384	\$1,476	\$1,599	\$1,722	\$1,845	\$1,968
	84"	\$806	\$913	\$1,026	\$1,169	\$1,276	\$1,389	\$1,508	\$1,610	\$1,744	\$1,878	\$2,012	\$2,146
	96"	\$866	\$982	\$1,105	\$1,262	\$1,378	\$1,500	\$1,632	\$1,743	\$1,889	\$2,034	\$2,179	\$2,324
	108"	\$974	\$1,105	\$1,243	\$1,419	\$1,550	\$1,688	\$1,836	\$1,961	\$2,125	\$2,288	\$2,452	\$2,615
	120"	\$1,083	\$1,228	\$1,381	\$1,577	\$1,722	\$1,876	\$2,040	\$2,179	\$2,361	\$2,542	\$2,724	\$2,906
VALANCE		\$52	\$62	\$72	\$82	\$93	\$103	\$113	\$124	\$134	\$144	\$155	\$165

# SLIDING PANEL PRICING – PRICE GROUPS D-F

All tracks and valance boards over 90" wide will be spliced to avoid oversize freight charges.

## WIDTH

PRICE GROUP D Antilles Camden Chelsea Halifax Harbor Montana Nantucket Parchment Portland Sonoma Tortola	LENGTH	WIDTH											
		60"	72"	84"	96"	108"	120"	132"	144"	156"	168"	180"	192"
	60"	\$730	\$826	\$928	\$1,053	\$1,149	\$1,251	\$1,352	\$1,443	\$1,563	\$1,683	\$1,803	\$1,924
	72"	\$799	\$906	\$1,019	\$1,159	\$1,266	\$1,379	\$1,495	\$1,596	\$1,729	\$1,862	\$1,995	\$2,128
	84"	\$868	\$985	\$1,109	\$1,266	\$1,383	\$1,507	\$1,637	\$1,750	\$1,896	\$2,042	\$2,187	\$2,333
	96"	\$936	\$1,065	\$1,200	\$1,372	\$1,500	\$1,636	\$1,780	\$1,904	\$2,062	\$2,221	\$2,379	\$2,538
	108"	\$1,053	\$1,198	\$1,350	\$1,543	\$1,688	\$1,840	\$2,002	\$2,141	\$2,320	\$2,498	\$2,677	\$2,855
	120"	\$1,170	\$1,331	\$1,500	\$1,715	\$1,876	\$2,045	\$2,225	\$2,379	\$2,578	\$2,776	\$2,974	\$3,173
VALANCE		\$58	\$70	\$81	\$93	\$104	\$116	\$128	\$139	\$151	\$162	\$174	\$186

## WIDTH

PRICE GROUP E Alisia Andros Como Fay Peri Selene	LENGTH	WIDTH											
		60"	72"	84"	96"	108"	120"	132"	144"	156"	168"	180"	192"
	60"	\$824	\$932	\$1,047	\$1,188	\$1,296	\$1,411	\$1,525	\$1,627	\$1,763	\$1,899	\$2,034	\$2,170
	72"	\$901	\$1,021	\$1,149	\$1,308	\$1,428	\$1,556	\$1,686	\$1,801	\$1,951	\$2,101	\$2,251	\$2,401
	84"	\$979	\$1,111	\$1,251	\$1,428	\$1,560	\$1,700	\$1,847	\$1,974	\$2,138	\$2,303	\$2,467	\$2,632
	96"	\$1,056	\$1,201	\$1,354	\$1,547	\$1,692	\$1,845	\$2,008	\$2,147	\$2,326	\$2,505	\$2,684	\$2,863
	108"	\$1,188	\$1,351	\$1,523	\$1,741	\$1,904	\$2,076	\$2,259	\$2,416	\$2,617	\$2,818	\$3,019	\$3,221
	120"	\$1,320	\$1,502	\$1,692	\$1,934	\$2,116	\$2,306	\$2,510	\$2,684	\$2,908	\$3,131	\$3,355	\$3,579
VALANCE		\$66	\$79	\$92	\$105	\$118	\$131	\$144	\$157	\$170	\$183	\$197	\$210

## WIDTH

PRICE GROUP F Soft Jute	LENGTH	WIDTH											
		60"	72"	84"	96"	108"	120"	132"	144"	156"	168"	180"	192"
	60"	\$1,112	\$1,258	\$1,413	\$1,604	\$1,749	\$1,905	\$2,059	\$2,197	\$2,380	\$2,563	\$2,746	\$2,929
	72"	\$1,217	\$1,379	\$1,551	\$1,765	\$1,928	\$2,100	\$2,276	\$2,431	\$2,633	\$2,836	\$3,039	\$3,241
	84"	\$1,321	\$1,500	\$1,689	\$1,927	\$2,106	\$2,296	\$2,493	\$2,665	\$2,887	\$3,109	\$3,331	\$3,553
	96"	\$1,426	\$1,622	\$1,828	\$2,089	\$2,285	\$2,491	\$2,710	\$2,899	\$3,140	\$3,382	\$3,623	\$3,865
	108"	\$1,604	\$1,824	\$2,056	\$2,350	\$2,570	\$2,802	\$3,049	\$3,261	\$3,533	\$3,805	\$4,076	\$4,348
	120"	\$1,782	\$2,027	\$2,284	\$2,611	\$2,856	\$3,114	\$3,388	\$3,623	\$3,925	\$4,227	\$4,529	\$4,831
VALANCE		\$88	\$106	\$124	\$142	\$159	\$177	\$195	\$212	\$230	\$248	\$265	\$283

# SLIDING PANEL SURCHARGE PRICING

All tracks and valance boards over 90" wide will be spliced to avoid oversize freight charges.

## WIDTH

LIGHT-FILTERING LINERS <i>Light-filtering liners are the same color on both sides.</i>		LENGTH	WIDTH										
			60"	72"	84"	96"	108"	120"	132"	144"	156"	168"	180"
Beige Black Gray Soft White	60"	\$219	\$248	\$278	\$316	\$345	\$375	\$406	\$433	\$469	\$505	\$541	\$577
	72"	\$240	\$272	\$306	\$348	\$380	\$414	\$448	\$479	\$519	\$559	\$599	\$639
	84"	\$260	\$296	\$333	\$380	\$415	\$452	\$491	\$525	\$569	\$612	\$656	\$700
	96"	\$281	\$319	\$360	\$412	\$450	\$491	\$534	\$571	\$619	\$666	\$714	\$761
	108"	\$316	\$359	\$405	\$463	\$506	\$552	\$601	\$642	\$696	\$750	\$803	\$857
	120"	\$351	\$399	\$450	\$514	\$563	\$613	\$667	\$714	\$773	\$833	\$892	\$952
VALANCE		\$17	\$21	\$24	\$28	\$31	\$35	\$38	\$42	\$45	\$49	\$52	\$56

*\*If sliding panel is ordered with a liner, there will be no additional lined valance surcharge.*

## WIDTH

BLACK-OUT LINERS <i>Black-out liners are off white to the street.</i>		LENGTH	WIDTH										
			60"	72"	84"	96"	108"	120"	132"	144"	156"	168"	180"
Beige Espresso White	60"	\$292	\$330	\$371	\$421	\$459	\$500	\$541	\$577	\$625	\$673	\$721	\$769
	72"	\$320	\$362	\$408	\$464	\$506	\$552	\$598	\$639	\$692	\$745	\$798	\$851
	84"	\$347	\$394	\$444	\$506	\$553	\$603	\$655	\$700	\$758	\$817	\$875	\$933
	96"	\$375	\$426	\$480	\$549	\$600	\$654	\$712	\$761	\$825	\$888	\$952	\$1,015
	108"	\$421	\$479	\$540	\$617	\$675	\$736	\$801	\$857	\$928	\$999	\$1,071	\$1,142
	120"	\$468	\$532	\$600	\$686	\$750	\$818	\$890	\$952	\$1,031	\$1,110	\$1,190	\$1,269
VALANCE		\$23	\$28	\$32	\$37	\$42	\$46	\$51	\$56	\$60	\$65	\$70	\$74

*\*If sliding panel is ordered with a liner, there will be no additional lined valance surcharge.*

## NET FREIGHT SURCHARGE\*: \$40

*\*Freight surcharge applies for orders shipping within the continental U.S. For orders shipping to Alaska or Hawaii, please request a freight quote prior to placing your order.*



# WOVEN WOOD WARRANTY

## LIMITED LIFETIME WARRANTY

This product is warranted against defects in materials and workmanship, provided that:

1. The product was installed according to the product instructions.
2. Manufacturer recommendations were followed regarding limitations and specifications of the product.

Manufacturer reserves the right to determine if your shade warrants a repair or partial replacement of any parts. If necessary, Manufacturer will replace your shade with a new shade of equal or superior value. This shall be your sole remedy under this warranty.

This Limited Lifetime Warranty excludes all motors, controls and accessories, which are warranted for only a period of five years from the date of purchase. Failure to follow the proper installation, charging and use instructions will invalidate the warranty for motors, remotes, wands and hubs.

This Limited Lifetime Warranty applies only to the original retail purchaser with proof of purchase.

This Limited Lifetime Warranty does not cover the removal or installation of original or replacement shades. This Limited Lifetime Warranty does not cover damage or defects caused by, or resulting from improper maintenance, neglect or improper use, wear and tear, abuse, neglect, accidents, alteration, commercial use, installation, removal or reinstallation or exposure to excessive moisture.

## YOUR RIGHTS UNDER STATE LAW

These warranties give you specific legal rights. You may also have other rights which may vary from State to State. In no event shall the Manufacturer be liable for incidental or consequential damages or for any other direct or indirect damage, loss, cost, expense or fee. Some states do not allow the exclusion or limitation of incidental or consequential damages, so the above limitation or exclusion may not apply to you. These warranties are exclusive and in lieu of all other obligations, liabilities, disclaimers, or warranties.

# WALDEN SELECT

## ⚠️ WARNING

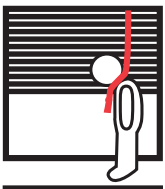

### Window Blind Cord Strangulation Risk

Window blinds with a damaged or loose tension device or retractable cord that fails to fully retract pose a strangulation risk to children. To avoid this potential strangulation risk, consider purchasing cordless products with inaccessible cords.

ANSI/WCMA A100.1-2022

## ⚠️ ADVERTENCIA

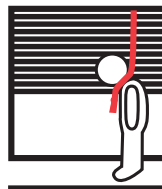

### Riesgo de Estrangulamiento en Cuerdas de Persianas

Las persianas con un dispositivo tensor suelto o dañado o con una cuerda retráctable que no se ajusta completamente representan un riesgo de estrangulación para los niños. Para evitar un posible riesgo de estrangulamiento, considere comprar productos inalámbricos o productos con cuerdas inaccesibles.

ANSI/WCMA A100.1-2022



Office: 972-564-0037

E-Mail: [customerservice@lonestarshutters.com](mailto:customerservice@lonestarshutters.com)

Website: [www.lonestarshutters.com](http://www.lonestarshutters.com)